

VVP MARKETING CO., LTD.



VVP FLOOR HINGE



GLASS DOOR ACCESSORIES





Tel: 756-2031
Tel: 1101-2535



MKT 20219



Certificate No. AJA002457

justusdwa



Reg. No. 059-A

Certificate No. AJA00/2457

Registration Certificate

*This is to certify that
the Quality Management Systems of*

CHAN SIN THAVEE CO., LTD.

*have been assessed by AJA Registrars and registered
against the requirements of*

BS EN ISO 9002 : 1994

Certificate No: AJA002457

Date of Original Registration: 10.07.00

Date of Expiry: 10.07.03

Date of Re-Registration: N/A



Reg. No. 059-A



Jonathan D. Dixon
Regional CEO (High) - AJA Registrars

This certificate is issued in respect of the locations & scope of registration detailed in the Associated Registration Schedule.
This certificate is the property of AJA Registrars and must be returned on request.

CERTIFICATE





SIRIM QAS International Sdn. Bhd. (Incorporated in Malaysia)
 40110, Jalan Alam Shah, 50000, Kuala Lumpur, Malaysia
 Tel: 03-55484833

REPORT NO: 2007MA0630 PAGE: 1 OF 26
 TEST REPORT

This Test Report refers only to samples submitted by the applicant to SIRIM QAS International Sdn. Bhd. This Test Report shall not be used for advertising purposes by any means or forms without written approval from Executive Director, SIRIM QAS International Sdn. Bhd. Please refer overleaf for Conditions Relating To The Use of Test Report.

Applicant : VVP SPIDER SIN. BHD.
 7560, Jalan Long Yunus,
 13200, Kota Bharu, Kelantan

Manufacturer : CHANIN THAVEE CO.LTD.
 100/100, Chulalongkorn Road,
 Bangkhuntien, Bangkok 10150, Thailand

Product : Floor Door Closer / Hinge

Reference Standard/ Method of test : BSEN 1154: 1997
 Building Hardware - Controlled door closing devices - Requirements and test methods.

Description of sample : Brand : VVP
 Quantity : 6 units

Our Ref : SQASMT/13/16

Date received : 14/12/2006

Job No : J2066050679

Issued date : 12 SEP 2007

Approved Signatures

(HASNI KAMAL HARON)
 Senior Technical Executive



(MOULI ESHWAR MURTHY, A)
 Mechanical and Acoustic (MAST) Testing Group
 Product Certification, Inspection & Testing Department

ใบรับรองพลา



G153659/AWI
 (SISIR)

TIS 759-2531
 TIS 1101-2535

Certificate No. AJA002457

sgshhd



MH 26219

File MH26219 Page 71-8 of 5 Issued: 12-20-99

RESULTS
 Initial Static Test - The door was opened 131 degrees. The door did not open to 185° and did not harm the closer.
 Final Static Test - The door was opened 132 degrees. The door did not open to 185° and did not harm the closer.
 CYCLE TEST (6.6):

METHOD

The door closer shall be installed in accordance with the manufacturer's instructions for 90 degrees of door opening. From a 90° opening angle, the closing time for the door was regulated such that the door closed in between 3 and 6 seconds. The door closer was then being pushed open to approximately 79 degrees and the door closer would bring the door back to the start position.

RESULTS

The door closer return the door to 0 degrees at the conclusion of the opening. No 10 test set-up could not overcome door closer force to open the door back into the 79 degrees mentioned above.

CONCLUSION

Examples of the products covered by this Report have been found to comply with the requirements for door closers in accordance with BS27760: 2005. The products are judged to be eligible for Classification and the class and the products are judged to be eligible for Classification and Classification marking such products submitted to the Publications Service procedure and any other applicable requirements of Underwriters Laboratories Inc. The products are considered as Classified by Underwriters Laboratories Inc.

Report by:

Alan Burns
 Senior Technical Executive
 Product Engineer

Reviewed by:

Edgar Woff Klemm
 Senior Technical Executive
 Senior Project Engineer



G153659/AWI
 (SISIR)

G153659/AWI

3/3

RESULTS

Sample Reference	VVP FC 04 Floor Mounted Door Closer
Closing moment at an opening angle of 2° (Nm)	At 5,000 cycles 28
Opening moment at an opening angle of 2°C (Nm)	At 500,000 cycles 31
Examination of door closer at the end of 500,000 cycles.	At 5,000 cycles 37
	At 500,000 cycles 38
	Passed

Note: Before commencing the test the door closer was adjusted to give a closing time of 6 seconds from a 90° opening.

LEONG YEW FAI
 TESTING OFFICER

Mohd
 MOHD BIN LAWI
 FOR MANAGER
 MECHANICAL TECHNOLOGY CENTRE



สำนักงานมาตรฐานผลิตภัณฑ์อุตสาหกรรม
 กระทรวงพาณิชย์
 ถนนพหลโยธิน แขวงจตุจักร เขตจตุจักร กรุงเทพฯ 10300

สงวนลิขสิทธิ์
 (สงวน ทรัพย์สิน)
 กระทรวงพาณิชย์

สำนักงานมาตรฐานผลิตภัณฑ์อุตสาหกรรม

สำนักงานมาตรฐานผลิตภัณฑ์อุตสาหกรรม
 กระทรวงพาณิชย์

CERTIFICATE





G130859/AWT
(BWP)



UL
CLASSIFIED



UL
CLASSIFIED
UL Classified
UL Classified
Certificate No. A44002401
MKT 202111

INSTALLATION DIMENSIONS

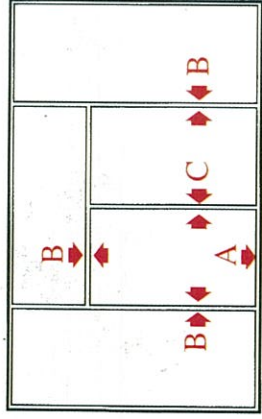

Dimensions : B 2 - 4 mm.
A 7 - 10 mm.
C 3 - 5 mm.

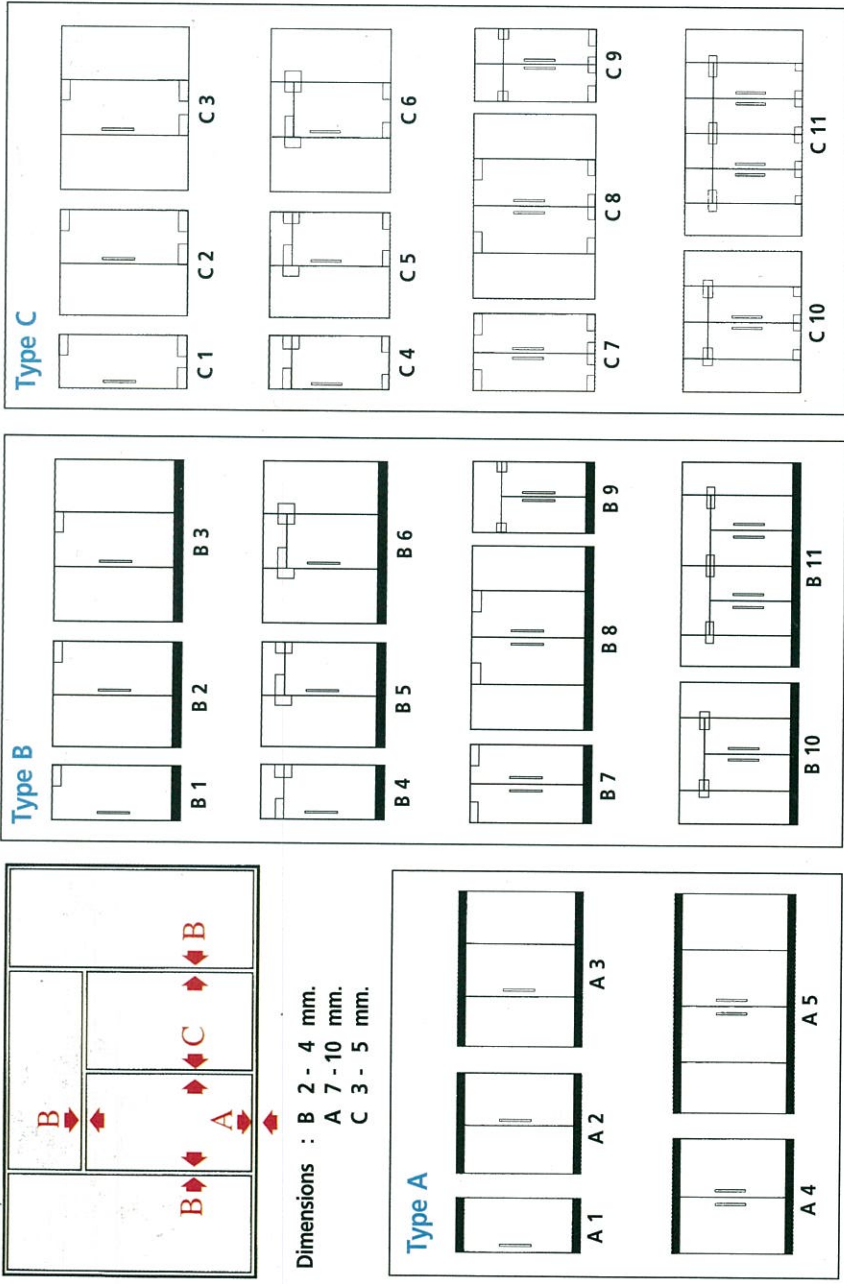

อุปกรณ์ต่าง ๆ สำหรับติดตั้งกระจก ACCESSORIES FOR GLASS FITTING



AT 040
Lock keeper plate stainless
steel with brass floor plug



AT 050
Profile cylinder

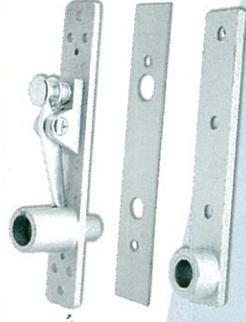

AT 110
Top centre with 15 mm. pivot



AT 140
Fixing plate with pivot



AT 141
Pivot with stainless steel
fixing plate



AT 170
Arm for floor hinge



AT 180
Floor pivot bearing with
flat tapered spindle



AT 150
Pivot with including
brass wall plug



AT 190
Threaded rod zinc plated
with solid brass wall plug

STANDARD FINISH
 PS = POLISHED STAINLESS
 SS = SATIN STAINLESS
 PB = POLISHED BRASS



FL 50

ตัวหนีบเชื่อมขนาดเล็ก
 Small Connection fitting



ปะกวยล้อประตูกับพื้น

Patch lock with cylinder and escutcheon
 for profile cylinder and masterkey available

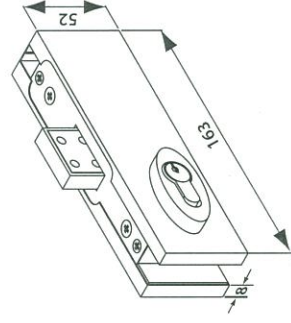
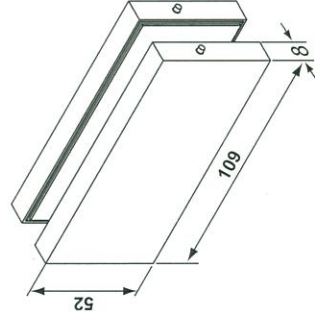
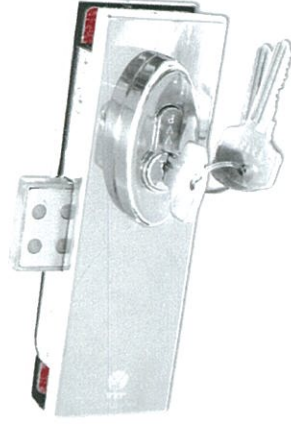

FT 42

FT 51

ตัวหนีบเชื่อมแบบคู่ มีครบ
 Fin fitting for back-to-back
 doors complete with pivot

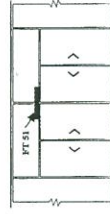

FL 52 / FL 53

ปะกวยล้อกลางประตู
 Center lock and center lock keeper

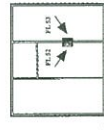

FL 52

FL 53

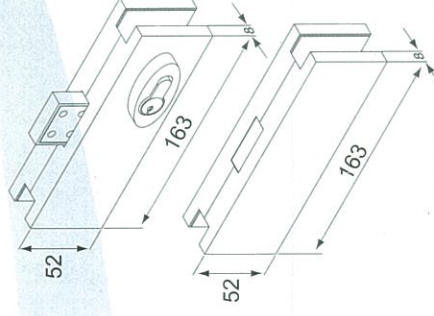
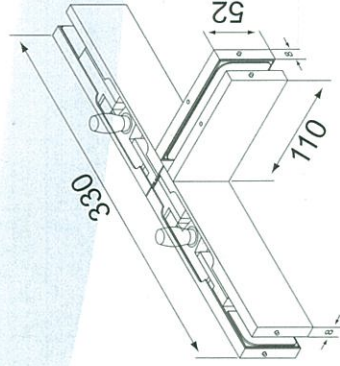

STANDARD FINISH
 PS = POLISHED STAINLESS
 SS = SATIN STAINLESS
 PB = POLISHED BRASS



UL
 CLASSIFIED
 MHT 26219

TB 799-2531
 TB 1101-2535

0132699AW1
 (3339)

Certification No. AJA002457

ຕັດສິນສູນ:ຈາກ

GLASS FITTING

FT 60

ຕັດສິນສູນ:ຈາກ 4 ມູມ Connection fitting

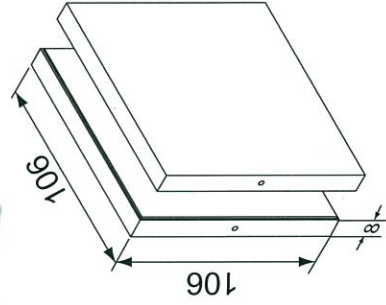
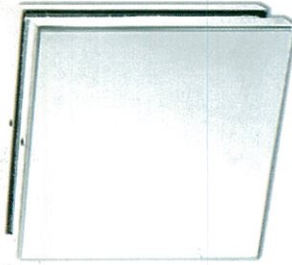

FT 61

ຕັດສິນສູນຂັ້ນເລັ່ງພັດກັບ
 Angle over panel fitting
 with pivot

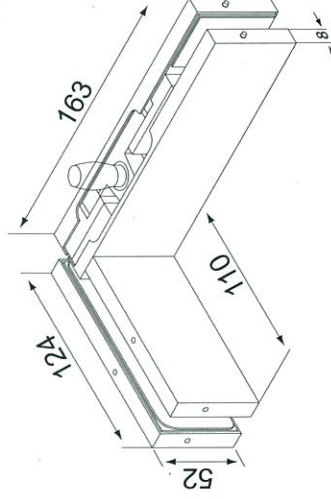
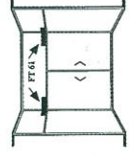

FT 62

ຕັດສິນສູນ:ຈາກ 4 ມູມ Connection fitting
 with fin fitting included

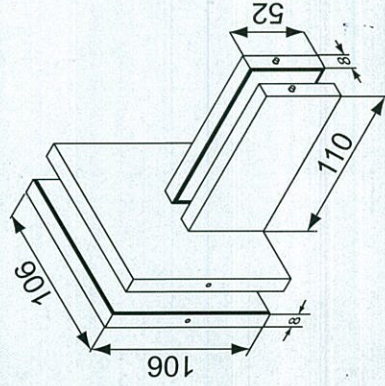
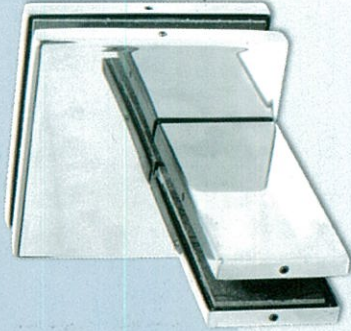
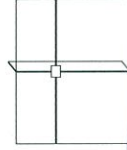

FT 63

ຕັດສິນສູນແຂ້ວ Sliding fitting

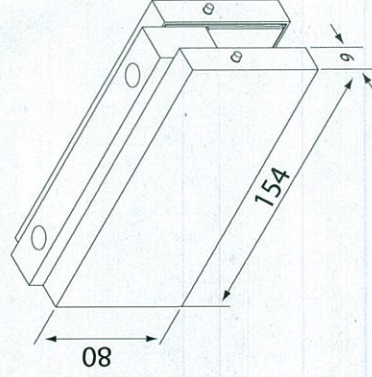
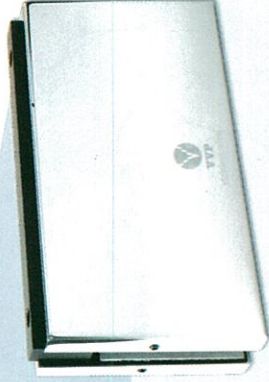
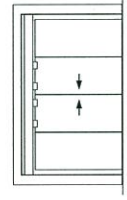



STANDARD FINISH
 PS = POLISHED STAINLESS
 SS = SATIN STAINLESS
 PB = POLISHED BRASS

TB 700-2531
 TB 1101-2533

DOOR RAIL MADE BY ORDER

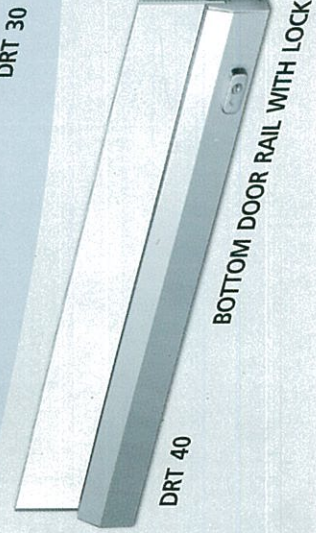
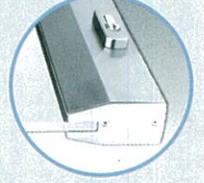
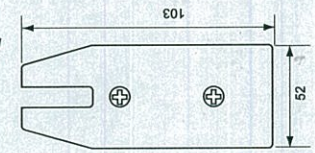
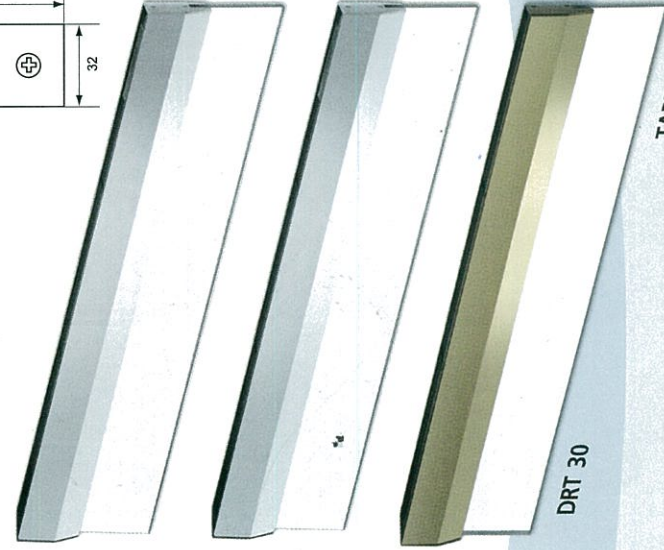
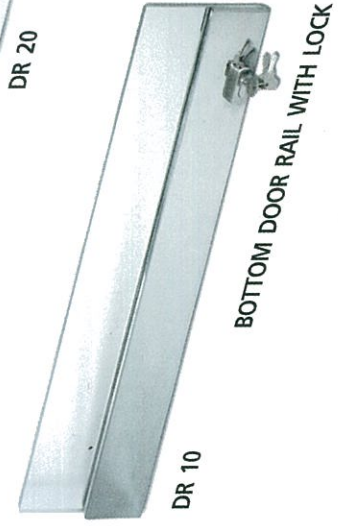
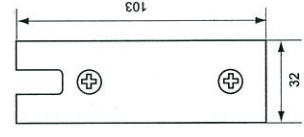
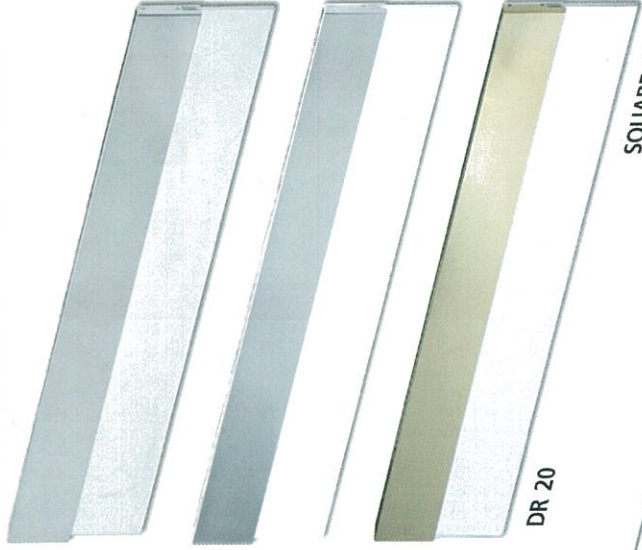
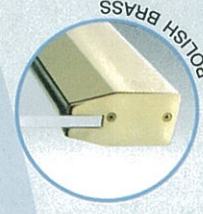
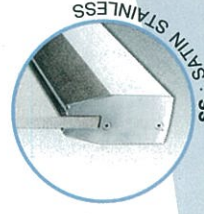
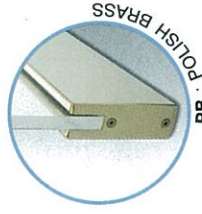
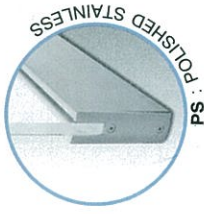

STANDARD FINISH
 PS = POLISHED STAINLESS
 SS = SATIN STAINLESS
 PB = POLISHED BRASS



MH 20219

TS 1101-2335

G13X55/AW1
 (SS/PS)

Certificate No. AJA002087

HD 101

Size/mm.

Art No.	L	D	H
2101	305	25	75
2102	350	25	75
2103	305	32	90
2104	350	32	90
2105	450	38	115
2108	450	32	90
2109	600	32	90
2110	600	38	115

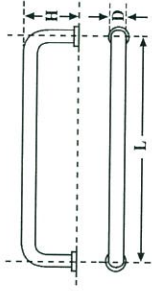
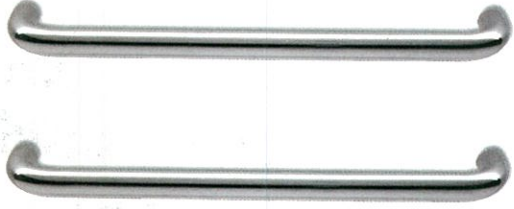

HD 102

Size/mm.

Art No.	L	D	H
2201	130	25	73
2202	200	25	118
2203	200	32	120

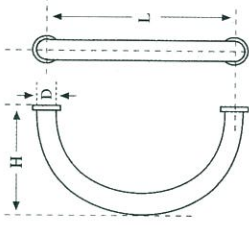

HD 103

Size/mm.

Art No.	L	D	H
2301	305	25	75
2302	305	32	90
2303	350	25	75
2304	350	32	90

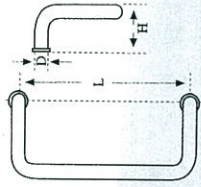

HD 104

Size/mm.

Art No.	L	D	H
2401	200	25	75
2402	200	32	90
2403	305	32	90
2404	350	32	90

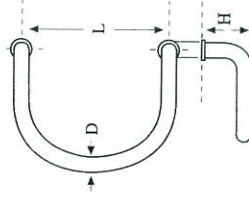

HD 105

Size/mm.

Art No.	L	D	H
2501	200	25	75

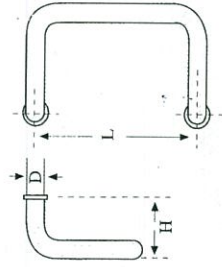

HD 106

Size/mm.

Art No.	L	D	H
2601	318	25	75
2602	318	32	90

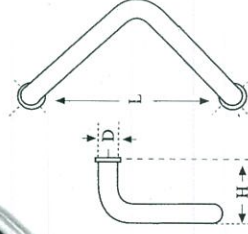
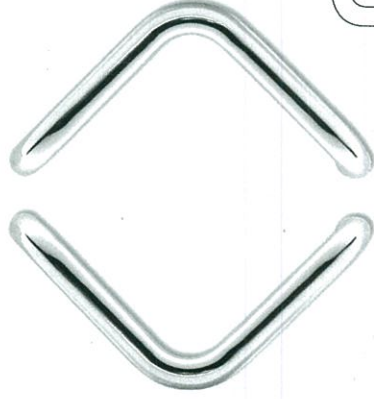

PULL HANDLE

İhtiyaçlarınız için



STANDARD FINISH
 PS = POLISHED STAINLESS
 SS = SATIN STAINLESS
 PB = POLISHED BRASS



010368/AW1 (S&P)
 TIS 1701-2531
 TIS 1701-2530

MH 2819

Certificate No. A1402747

มือจับประตูกระจก

PULL HANDLE

HD 107

Size/mm.

Art No.	L	W	H	D	P
2701	203	152	63	19	50
2702	280	203	63	19	50
2703	311	254	63	19	50

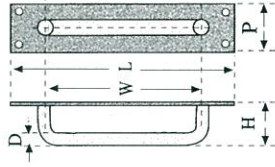
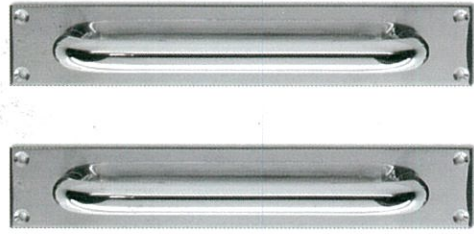

HD 108

Size/mm.

Art No.	L	D	H	W
2801	100	25	75	225
2802	100	32	82	232

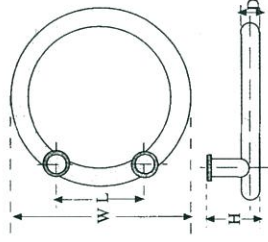

HD 109

Size/mm.

Art No.	L	D	H	W
2901	100	25	75	225

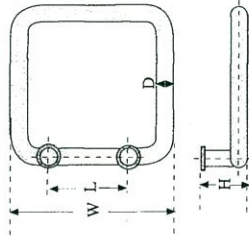

HD 110

Size/mm.

Art No.	L	D	W	H
2011	450	25	305	75
2012	450	32	305	90
2013	500	25	305	75
2014	500	32	305	90
2015	600	25	305	75

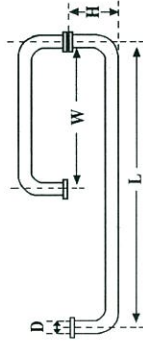

HD 111

Size/mm.

Art No.	L	D	A	H
2111	450	25	550	75
2112	450	32	550	32

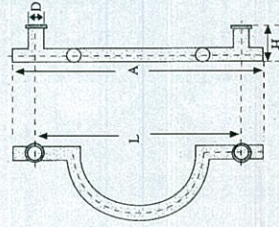

HD 112

Size/mm.

Art No.	L	D	H
2211	130	25	73
2212	200	25	118
2213	200	32	120

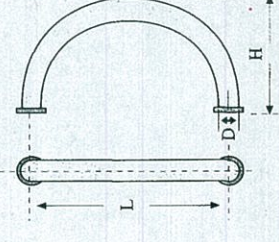

STANDARD FINISH
 PS = POLISHED STAINLESS
 SS = SATIN STAINLESS
 PB = POLISHED BRASS



تولیدات: صنایع

HD 113



Size/mm.

Art No.	L	D	H
2311	200	25	75
2312	305	25	75
2313	305	32	82
2314	350	32	82

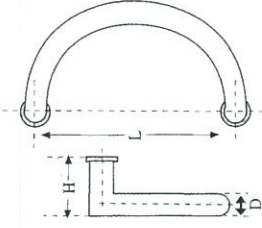

HD 114



Size/mm.

Art No.	L	D	H
2411	600	25	75
2412	600	32	82

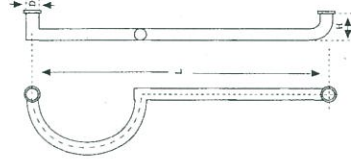

HD 116



Size/mm.

Art No.	L	D	A	H	B
2611	140	25	200	70	75
2612	225	25	305	70	75
2613	225	32	305	80	82
2614	292	32	350	80	82

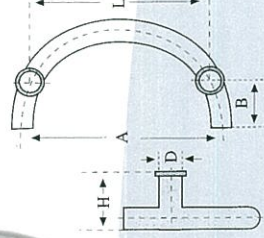

HD 117



Size/mm.

Art No.	L	D	H
2711	305	25	75
2712	350	25	75
2713	350	32	90
2714	425	25	75
2715	425	32	90
2716	450	25	75
2717	450	32	90
2718	600	32	90

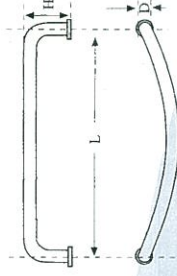

HD 118

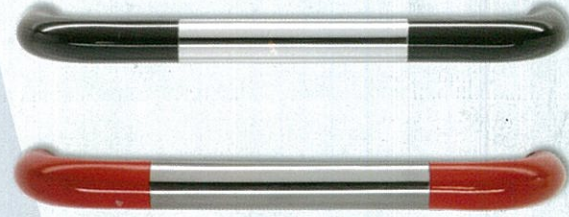

Size/mm.

Art No.	L	D	H
2811	305	25	75
2812	350	25	75
2813	305	32	90
2814	350	32	90
2815	450	38	115
2816	450	50	120
2817	600	63	130

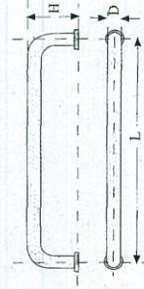

HD 120



Size/mm.

Art No.	L	D	W	H
2021	305	32	450	45
2022	350	38	600	45
2023	350	50	600	45

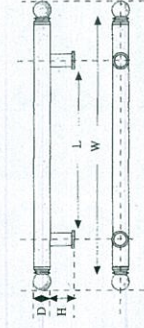

PULL HANDLE



STANDARD FINISH
 PS = POLISHED STAINLESS
 SS = SATIN STAINLESS
 PB = POLISHED BRASS



มือจับประตูกระจก

PULL HANDLE



HD 121

Size/mm.

Art No.	L	D	H
2121	485	25	75
2122	485	32	90

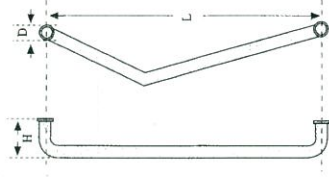

HD 122

Size/mm.

Art No.	L	D	H
2221	450	25	75
2222	450	32	90

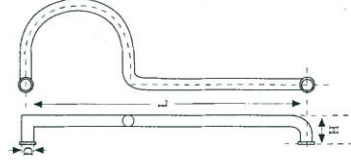
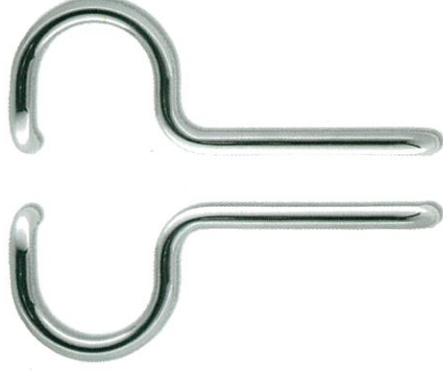

HD 123

Size/mm.

Art No.	L	D	H
2321	450	25	75
2322	450	32	90

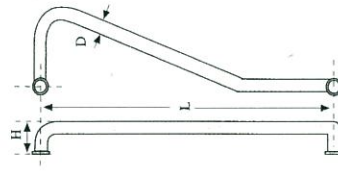
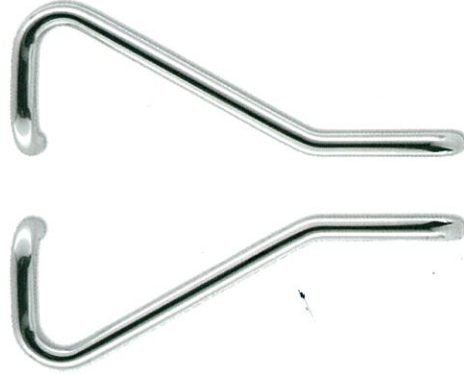

HD 124

Size/mm.

Art No.	L	D	H
2421	450	25	75
2422	450	32	90

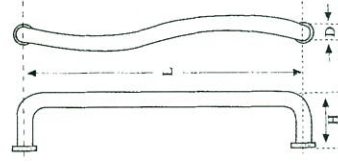

HD 125

Size/mm.

Art No.	L	D	H
2521	600	25	75
2522	600	32	90

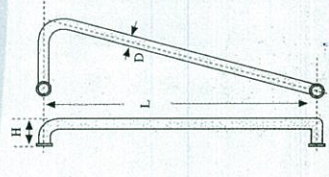
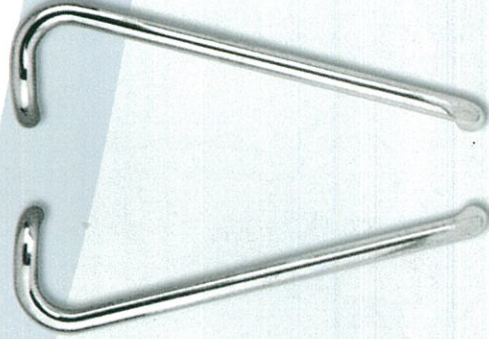

HD 126

Size/mm.

Art No.	L	D	H	W	A
2621	450	25	75	124	600
2622	450	32	90	124	600

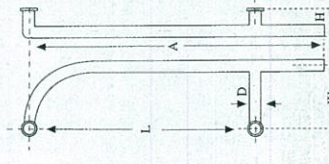
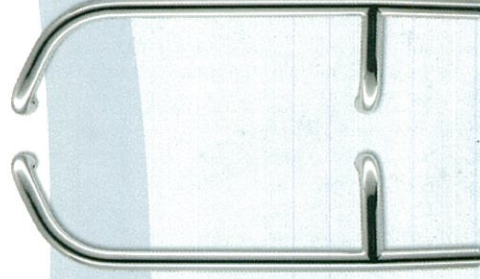

STANDARD FINISH
 PS = POLISHED STAINLESS
 SS = SATIN STAINLESS
 PB = POLISHED BRASS



TEL: 701 2033
 TIS: 1101-2033

SAH 28210

Certificate No. AJA0070487

tuotus:gn:an

HD 127

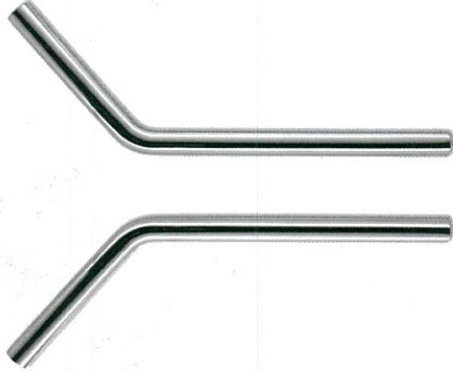

Size/mm.

Art No.	L	D	H	A
2721	305	25	75	550
2722	305	32	82	550

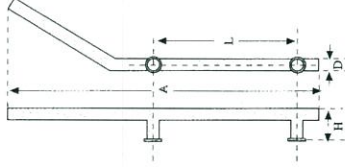

HD 128



Size/mm.

Art No.	L	D	A	H
2821	450	25	600	75
2822	450	32	600	82

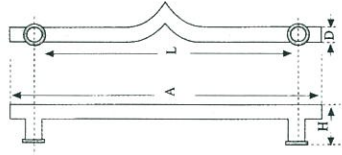

HD 129

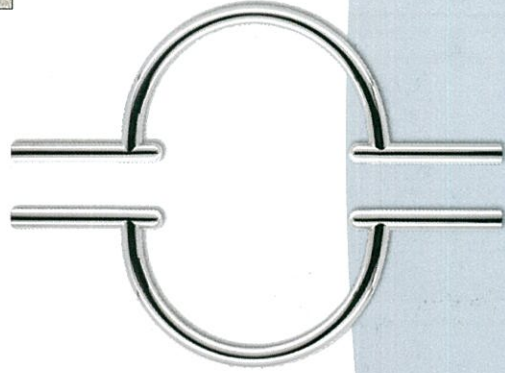

Size/mm.

Art No.	L	D	H	A	W
2921	450	25	75	600	210
2922	450	32	82	600	210

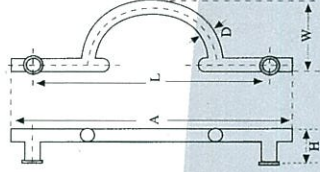

HD 132

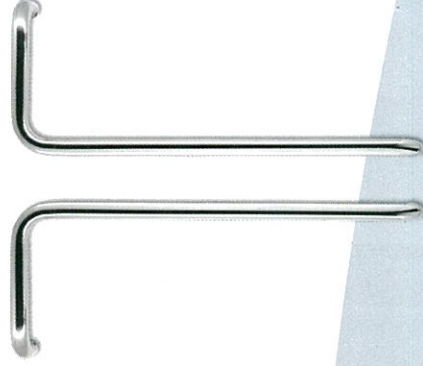

Size/mm.

Art No.	L	D	H	W
2231	450	25	70	210
2232	600	25	70	210
2233	800	32	80	210
2234	1000	32	80	210

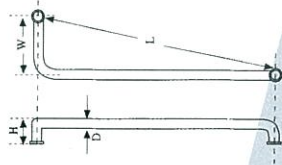

HD 134



Size/mm.

Art No.	L	D	H
2431	450	25	80
2432	450	32	80

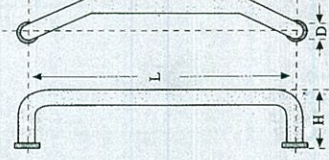

HD 136



Size/mm.

Art No.	L	D	H
2631	305	25	90
2632	350	25	90
2633	305	32	90
2634	350	32	90
2635	450	38	95

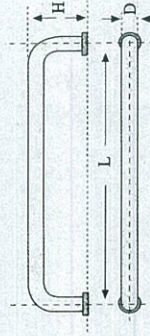

PULL HANDLE



STANDARD FINISH
 PS = POLISHED STAINLESS
 SS = SATIN STAINLESS
 PB = POLISHED BRASS



มือจับประตูกระจก

PULL HANDLE



HD 138

Size/mm.

Art No.	L	D	H
2731	200	25	90
2732	305	32	90

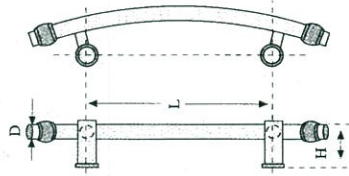

Size/mm.

Art No.	L	D	H
2831	200	25	90
2832	305	32	90
2833	350	38	90

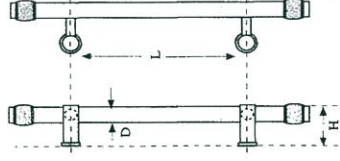
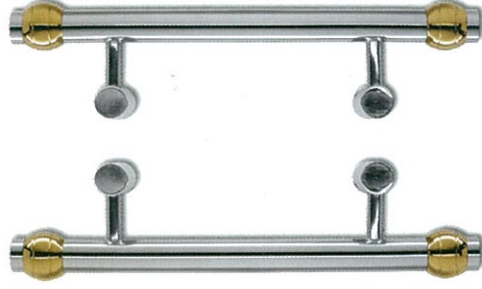

HD 137

Size/mm.

Art No.	L	D1	D2	H
2931	350	20	32	90
2932	450	20	32	90
2933	600	20	32	90

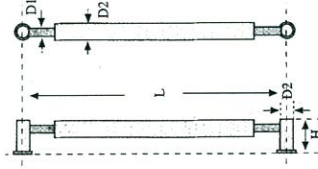

HD 140

Size/mm.

Art No.	L	D1	D2	H
2041	350	20	32	90
2042	450	20	32	90
2043	600	20	32	90

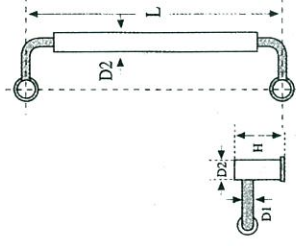
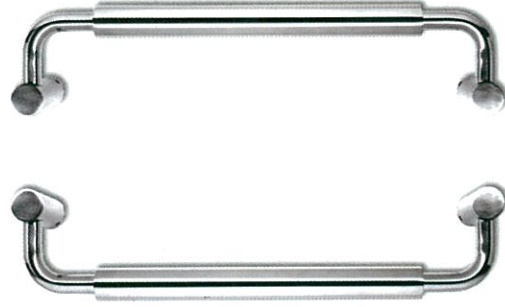

HD 141

Size/mm.

Art No.	L	D1	D2	H
2141	350	20	32	90
2142	450	20	32	90
2143	600	20	32	90

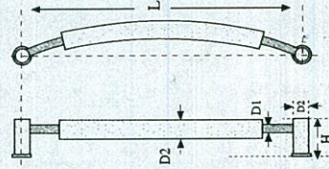
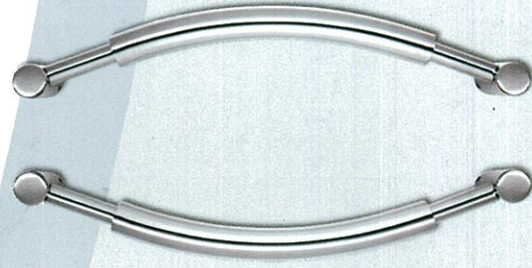

HD 142

Size/mm.

Art No.	L1	L2	D	H
2241	305	450	25	45
2242	450	600	25	45
2243	305	450	32	45
2244	450	600	32	45
2245	600	800	32	45
2246	800	1000	32	45

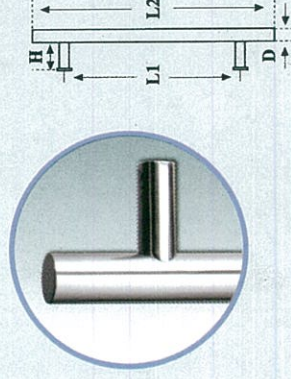

STANDARD FINISH
 PS = POLISHED STAINLESS
 SS = SATIN STAINLESS
 PB = POLISHED BRASS



TIS 799-2531
 TIS 1101-3535



MH 20219



Certificate No. A14202424

تیوٹس:قن:ن

HD 143

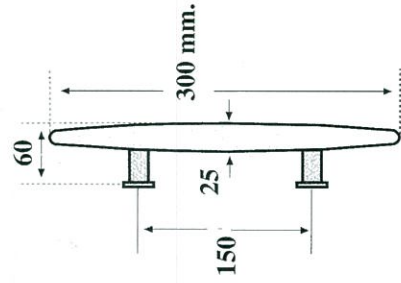
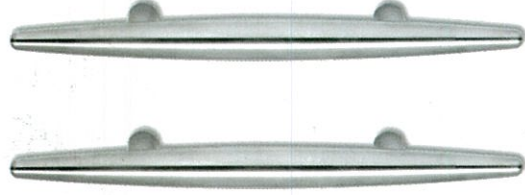

HD 144

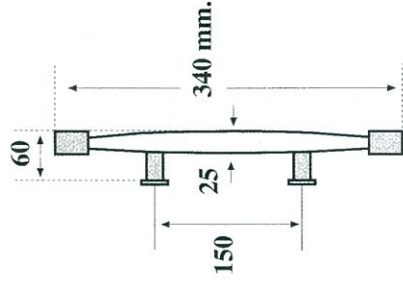
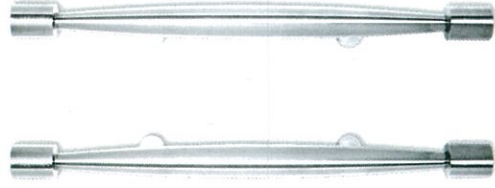

HD 145

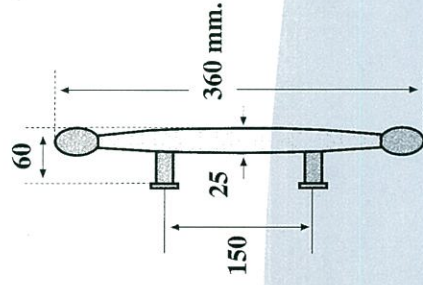
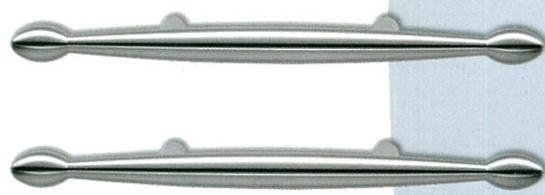

HD 146

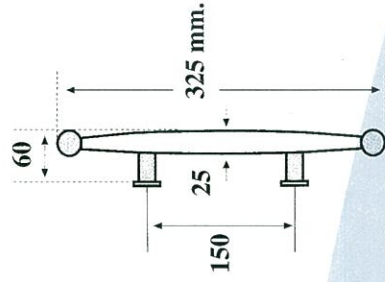

PULL HANDLE

HD 147

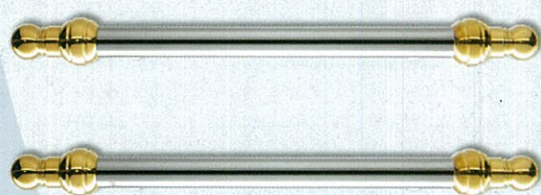

Art No.	L	D	H
2741	450	32	45
2742	600	32	45
2743	800	38	45
2744	1000	38	45

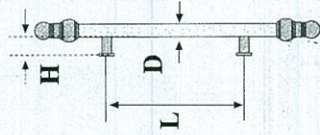

HD 148



Art No.	L	D	H
2841	450	38	45
2842	600	38	45
2843	800	50	45
2844	1000	50	45

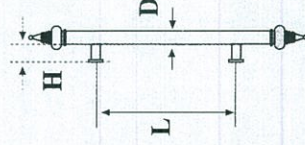

STANDARD FINISH
 PS = POLISHED STAINLESS
 SS = SATIN STAINLESS
 PB = POLISHED BRASS



มือจับประตูกระจก

PULL HANDLE



HD 149

Size/mm.

Art No.	L	D	H
2941	305	25	45
2942	350	25	45
2943	305	32	45
2944	350	32	45
2945	450	32	45
2946	450	38	45
2947	600	32	45
2948	600	38	45

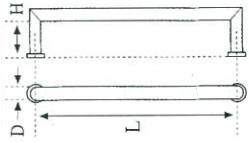
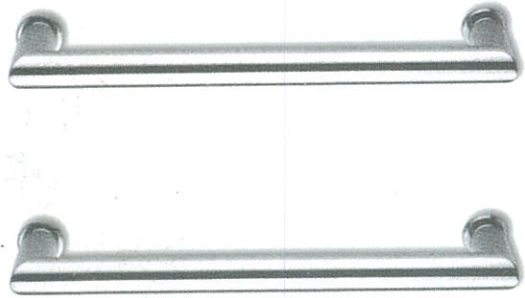

HD 150

Size/mm.

Art No.	L1	L2	D	H
2051	305	450	25	45
2052	450	600	25	45
2053	305	450	32	45
2054	450	600	32	45
2055	600	800	32	45
2056	800	1000	32	45

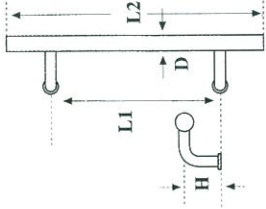
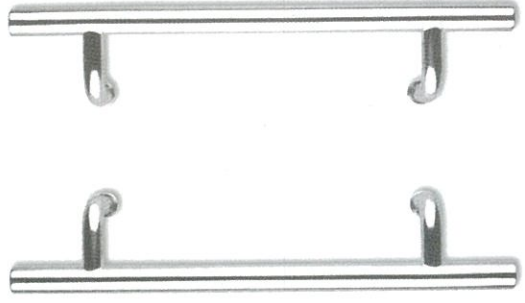

HD 151

Size/mm.

Art No.	L1	L2	D1	D2	H
2151	450	550	25	50	45

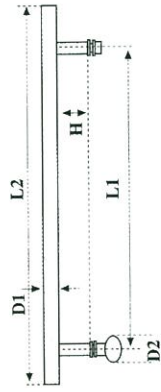

HD 152

Size/mm.

Art No.	L	D1	D2	H
2251	450	25	50	45

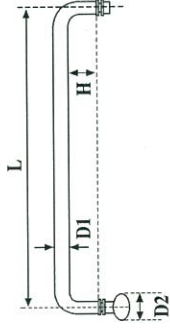

HD 153

Size/mm.

Art No.	L	D	H
2351	305	25x25	45
2352	305	32x32	45
2353	350	25x25	45
2354	350	32x32	45

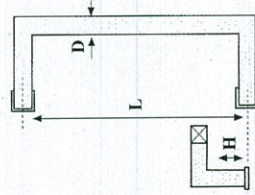
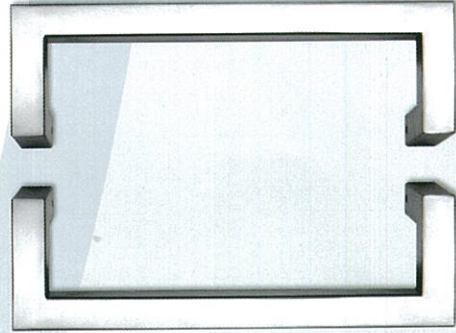

HD 154

Size/mm.

Art No.	L	D	H
2451	305	25x25	45
2452	305	32x32	45
2453	350	25x25	45
2454	350	32x32	45
2455	450	25x25	45
2456	450	32x32	45

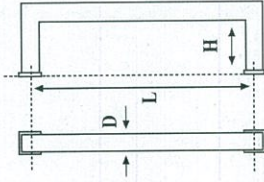
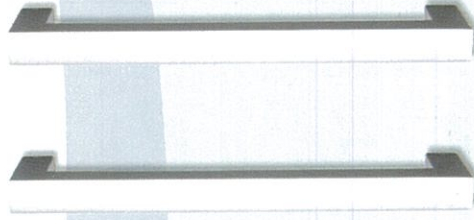

STANDARD FINISH
 PS = POLISHED STAINLESS
 SS = SATIN STAINLESS
 PB = POLISHED BRASS

0133669/AW1
 (PS/SP)

TIS 794-2531
 TIS 1101-2533

CLASSIFIED
 UL
 MH 28219

UL
 LISTED
 ENEC
 APPROVED
 Certificate No. A30002457

புல்லு:கு:ச:ன

HD 155

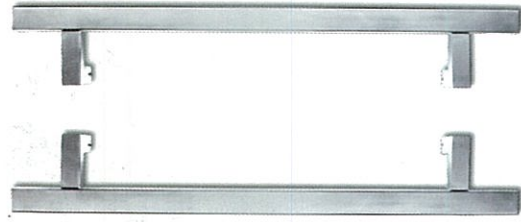

Size/mm.

Art No.	L1	L2	D	H
2551	305	450	25x25	45
2552	350	500	25x25	45
2553	305	450	32x32	45
2554	350	500	32x32	45
2555	450	600	32x32	45
2556	600	800	32x32	45
2557	800	1000	32x32	45

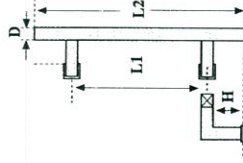

HD 156



Size/mm.

Art No.	L1	L2	D	H
2661	305	450	25x25	45
2662	350	500	25x25	45
2663	305	450	32x32	45
2664	350	500	32x32	45
2665	450	600	32x32	45
2666	600	800	32x32	45
2667	800	1000	32x32	45

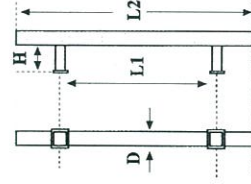

HD 157



Size/mm.

Art No.	L1	L2	D1	D2	H
2751	305	450	40	20	45
2752	350	500	40	20	45
2753	450	600	40	20	45
2754	600	800	40	20	45
2755	800	1000	40	20	45

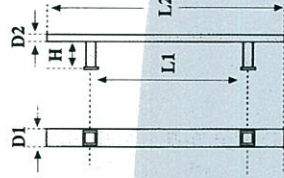

HD 158



Size/mm.

Art No.	L1	L2	D1	D2	H
2851	305	450	20	40	45
2852	350	500	20	40	45
2853	450	600	20	40	45
2854	600	800	20	40	45
2855	800	1000	20	40	45

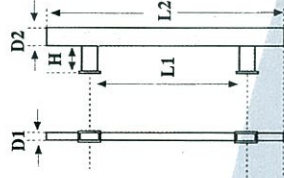

HD 159

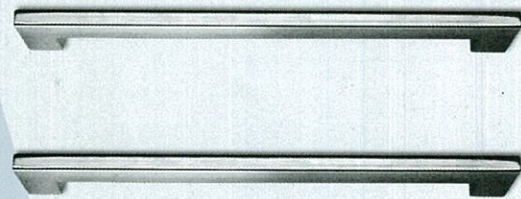

Size/mm.

Art No.	L	D1	D2	H
2951	305	20	40	45
2952	350	20	40	45
2953	450	20	40	45
2954	600	20	40	45
2955	800	20	40	45

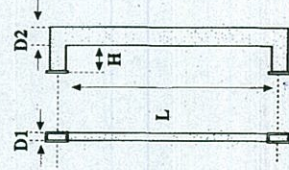

HD 160

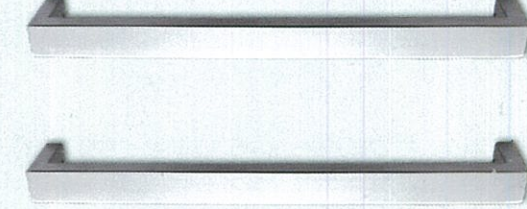

Size/mm.

Art No.	L	D1	D2	H
2061	305	40	20	45
2062	350	40	20	45
2063	450	40	20	45
2064	600	40	20	45
2065	800	40	20	45

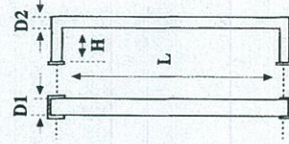

PULL HANDLE

STANDARD FINISH
 PS = POLISHED STAINLESS
 SS = SATIN STAINLESS
 PB = POLISHED BRASS



ฉบับประจำรุ่น

HD 161

Size/mm.

Art No.	L	D1	D2	H	W
2161	450	40	20	45	210
2162	600	40	20	45	210
2163	800	40	20	45	210
2164	1000	40	20	45	210

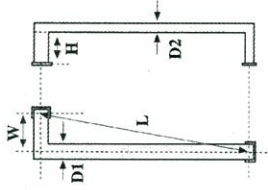
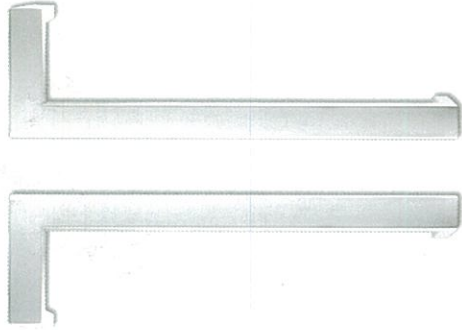

HD 162

Size/mm.

Art No.	L	D1	D2	H	W
2261	450	20	40	45	210
2262	600	20	40	45	210
2263	800	20	40	45	210
2264	1000	20	40	45	210

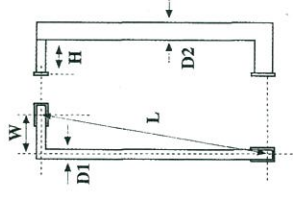

HD 163

Size/mm.

Art No.	L	D1	D2	H
2361	305	40	20	45
2362	350	40	20	45
2363	450	40	20	45
2364	600	40	20	45
2365	800	40	20	45

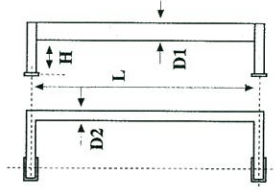
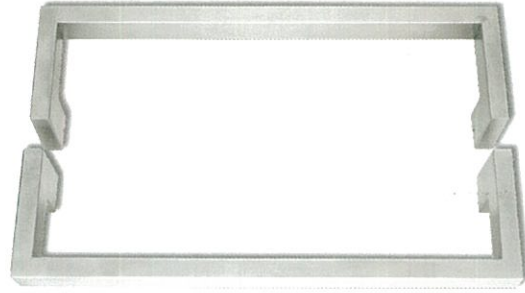

HD 164

Size/mm.

Art No.	L	D1	D2	H
2461	305	40	20	45
2462	350	40	20	45
2463	450	40	20	45
2464	600	40	20	45
2465	800	40	20	45

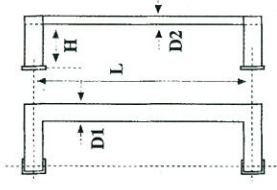

HD 165

Size/mm.

Art No.	L1	L2	D1	D2	H
2561	450	550	40	20	45

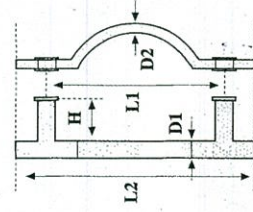
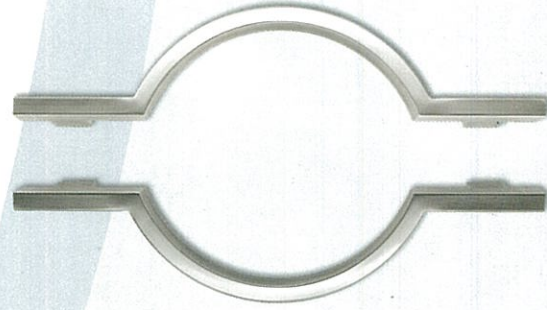

HD 166

Size/mm.

Art No.	L	D	H
2661	305	32x32	80

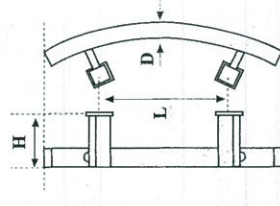
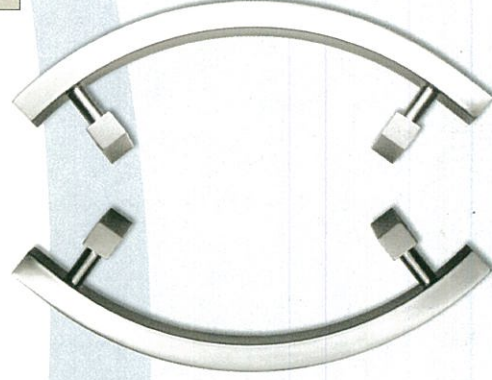

PULL HANDLE



STANDARD FINISH
 PS = POLISHED STAINLESS
 SS = SATIN STAINLESS
 PB = POLISHED BRASS



UL
 LISTED
 IMA 20210
 Certificate No. AJA002457

TIS 700-251
 TIS 101-255

0153624/1/1
 (8589)

tuotus:qns:vn

HD 167

Size/mm.

Art No.	L	D	H
2761	350	32x32	80
2762	450	32x32	80
2763	600	32x32	80

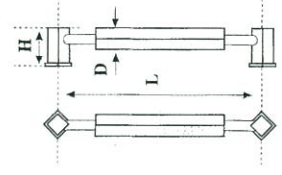
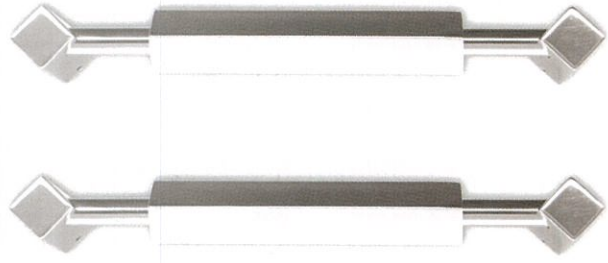

HD 168

Size/mm.

Art No.	L	D	H
2861	350	32x32	80
2862	450	32x32	80
2863	600	32x32	80

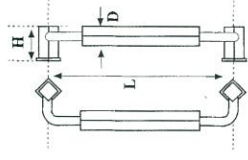
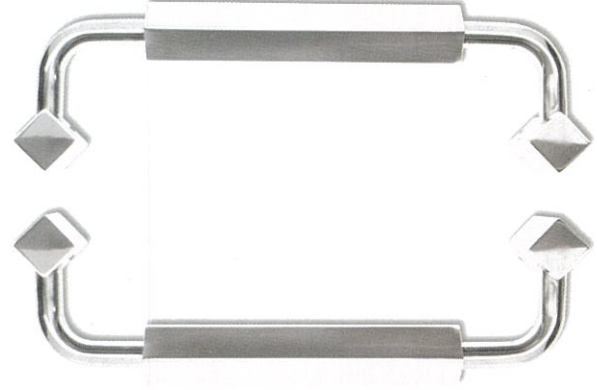

HD 169

Size/mm.

Art No.	L	D	H
2961	350	32x32	80
2962	450	32x32	80
2963	600	32x32	80

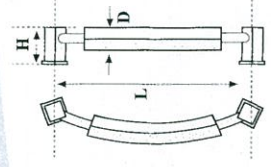
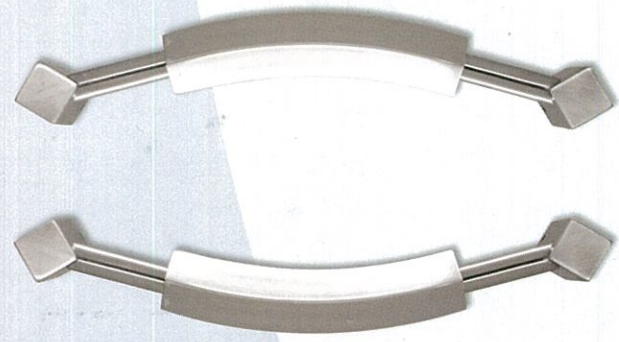

HD 170

Size/mm.

Art No.	L	D	H
2071	305	32x32	80

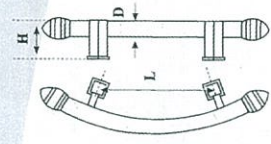
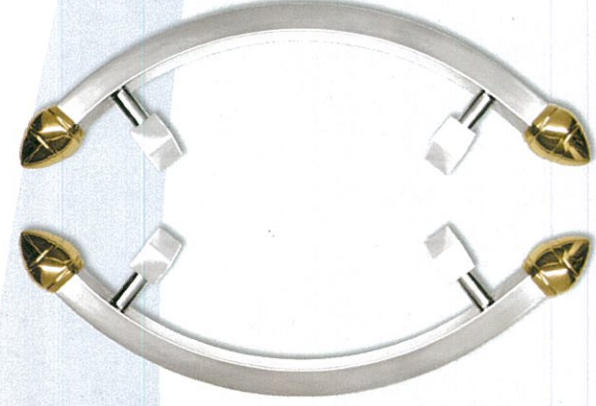

PULL HANDLE



STANDARD FINISH
 PS = POLISHED STAINLESS
 SS = SATIN STAINLESS
 PB = POLISHED BRASS



G1385AW1
 (8889)



TIS 554
 TIS 1107-2023



MH 28210



Certificate No. AA0020487

มือจับประตูกระจก

PULL HANDLE



HD 171

Size/mm.

Art No.	L	D1	D2	H
2171	350	20	40	45
2172	450	20	40	45
2173	600	20	40	45

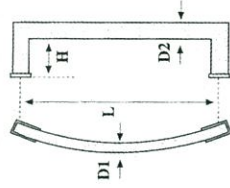

HD 172

Size/mm.

Art No.	L	D	H
2271	900	32	75
2272	1000	32	90

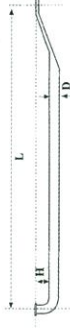

HD 174

Size/mm.

Art No.	L	A	D1	D2
2471	200	300	40	20
2472	150	200	40	20
2473	200	300	50	25
2474	150	200	50	25

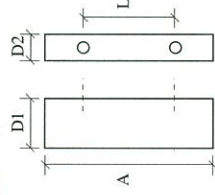
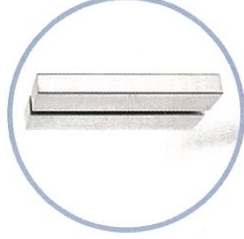

HD 173

Size/mm.

Art No.	L1	L2	D1	D2	H
2371	400	600	25	36	45
2372	600	800	25	36	45
2373	800	1000	25	36	45
2374	1000	1200	25	36	45

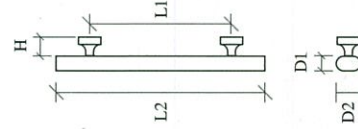
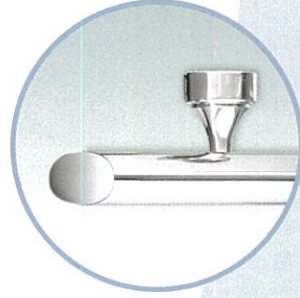

HD 175

Size/mm.

Art No.	L	D	A	H
2571	305	32	569	50
2572	350	32	615	50
2573	305	38	569	50
2574	350	38	615	50

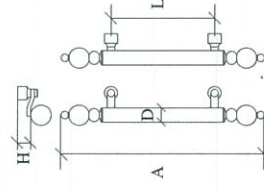
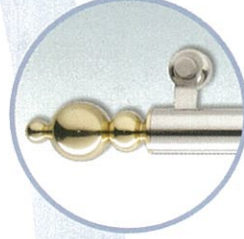

STANDARD FINISH
 PS = POLISHED STAINLESS
 SS = SATIN STAINLESS
 PB = POLISHED BRASS



TIS 759-2531
 TIS 1101-3335

MADE IN THAILAND
 Certificate No. AAJ000040

ထုတ်လုပ်သူများ

HD 176

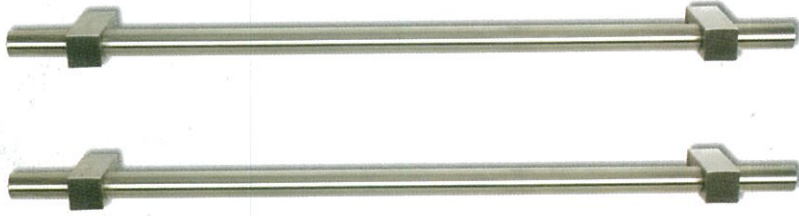

Size/mm.	Art No.	L	D	H	A	
	2671	305	25	25	85	450
	2672	450	25	25	85	600
	2673	600	25	25	85	800
	2674	800	25	25	85	1000

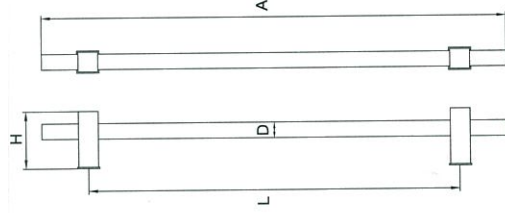

HD 177

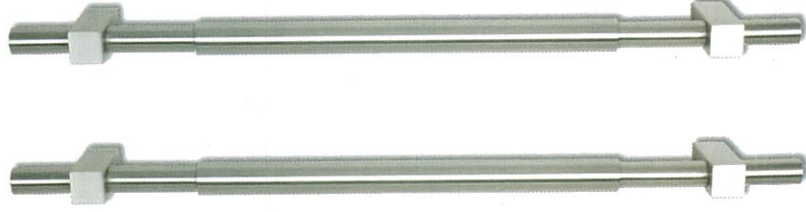

Size/mm.	Art No.	L	D1	D2	H	A
	2771	305	32	25	85	450
	2772	450	32	25	85	600
	2773	600	32	25	85	800
	2774	800	32	25	85	1000

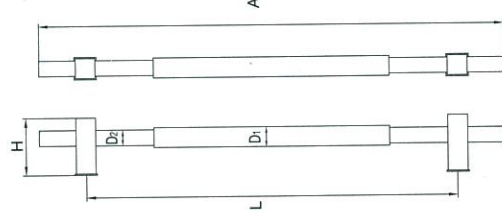

HD 178



Size/mm.	Art No.	L	D1	D2	H
	2871	350	32 x 32	25	85
	2872	450	32 x 32	25	85
	2873	600	32 x 32	25	85

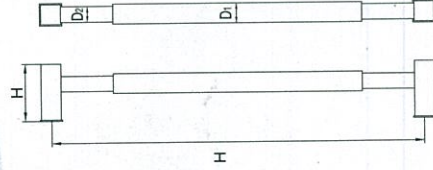

HD 179

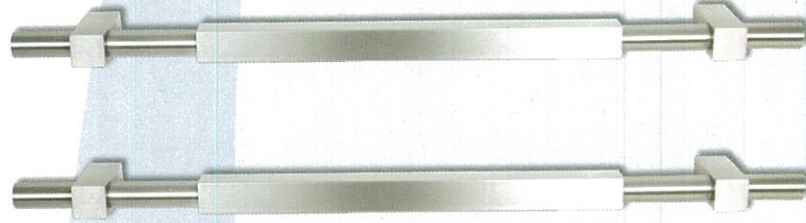

Size/mm.	Art No.	L	D1	D2	H	A
	2971	305	32 x 32	25	85	450
	2972	450	32 x 32	25	85	600
	2973	600	32 x 32	25	85	800
	2974	800	32 x 32	25	85	1000

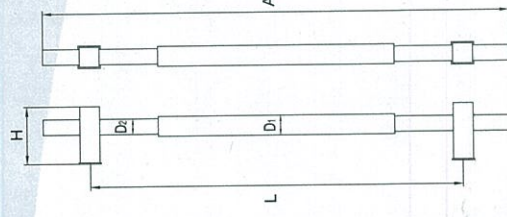

PULL HANDLE



STANDARD FINISH
 PS = POLISHED STAINLESS
 SS = SATIN STAINLESS
 PB = POLISHED BRASS



01-03629/AV1
 (S&B)



TIS 756-2531
 TIS 1107-2533



MH 20219



Certificate No. A-1402/2001

มือจับประตูกระจก

PULL HANDLE



HD 180



Size/mm.

Art No.	L	D	H	A
2081	305	32	85	450
2082	450	32	85	600
2083	600	32	85	800
2084	800	32	85	1000

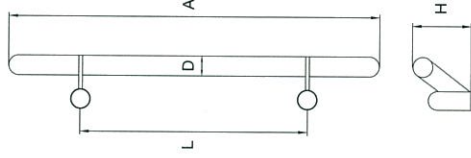

HD 181



Size/mm.

Art No.	L	D	H	A
2181	305	32	85	450
2182	450	32	85	600
2183	600	32	85	800
2184	800	32	85	1000

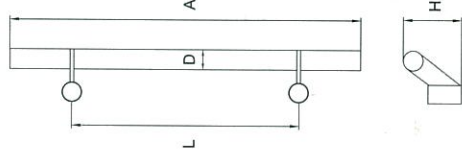

HD 182



Size/mm.

Art No.	L	D	H	A
2281	305	32	85	450
2282	450	32	85	600
2283	600	32	85	800
2284	800	32	85	1000

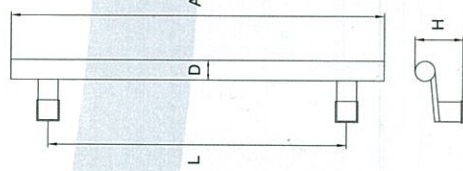

HD 183

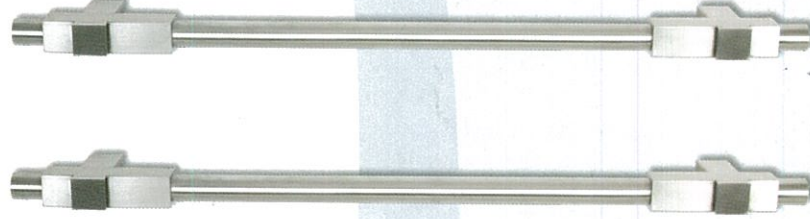

Size/mm.

Art No.	L	D	H	A
2381	305	25	85	450
2382	450	25	85	600
2383	600	25	85	800
2384	800	25	85	1000

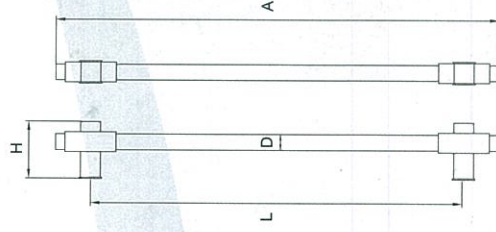

STANDARD FINISH
 PS = POLISHED STAINLESS
 SS = SATIN STAINLESS
 PB = POLISHED BRASS

CLASSIFIED
 UL
 TIS 759-331
 TIS 1101-3335
 MH 33219

UL
 USA
 LISTED
 Certificate No. A33002487

توتوس:قن:ان

PULL HANDLE

HD 184



Size/mm.

Art No.	L	D	H	A
2481	450	32	75	800
2482	600	32	75	1000
2483	800	32	75	1200

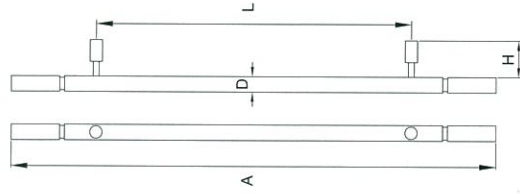

HD 185



Size/mm.

Art No.	L	D	H	A
2581	305	25	45	450
2582	450	25	45	600
2583	305	32	45	450
2584	450	32	45	600
2585	600	32	45	800
2586	800	32	45	1000

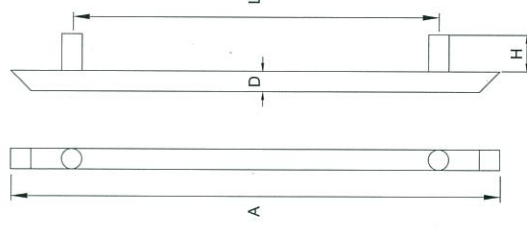

HD 186

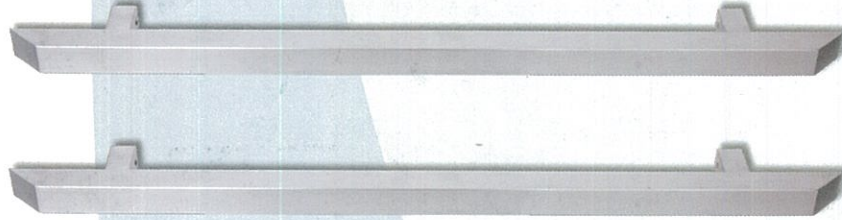

Size/mm.

Art No.	L	D	H	A
2681	305	32x32	45	450
2682	450	32x32	45	600
2683	600	32x32	45	800
2684	800	32x32	45	1000

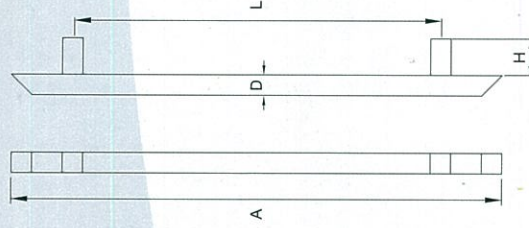

HD 187

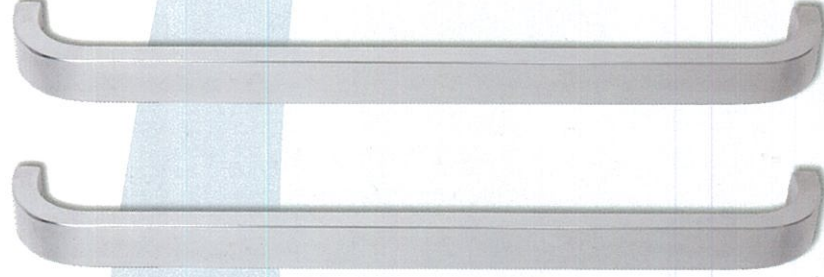

Size/mm.

Art No.	L	D1	D2	H
2781	305	40	20	45
2782	350	40	20	45
2783	450	40	20	45
2784	600	40	20	45

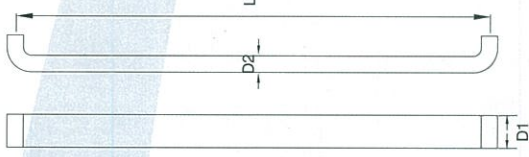

STANDARD FINISH
PS = POLISHED STAINLESS
SS = SATIN STAINLESS
PB = POLISHED BRASS



MH 26219

TIS 759-2531
TIS 1191-2535

G153658AW1
(PS/SS)

Certificate No. AH0007967

HD 188

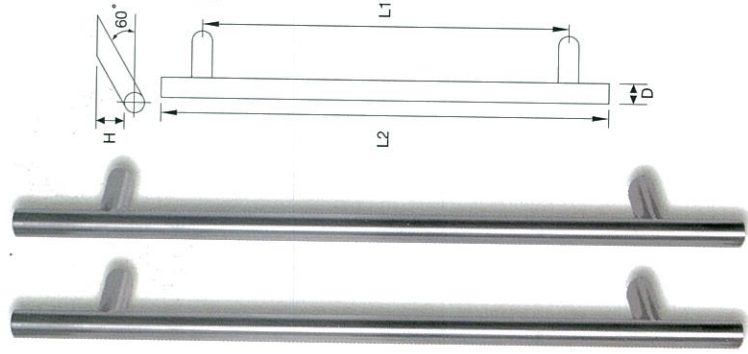

Size/mm.

Art No.	L1	L2	D	H
2881	305	450	32	45
2882	450	600	32	45
2883	600	800	32	45
2884	800	1000	32	45
2885	450	600	38	45
2886	600	800	38	45
2887	800	1000	38	45

HD 189



Size/mm.

Art No.	L	D	W	H
2981	450	25 x 25	305	45
2982	450	32 x 32	305	45
2983	500	25 x 25	305	45
2984	500	32 x 32	305	45
2895	600	25 x 25	305	45
2986	600	32 x 32	305	45
2987	711	25 x 25	305	45
2988	711	32 x 32	305	45
2989	800	25 x 25	305	45
2990	800	32 x 32	305	45

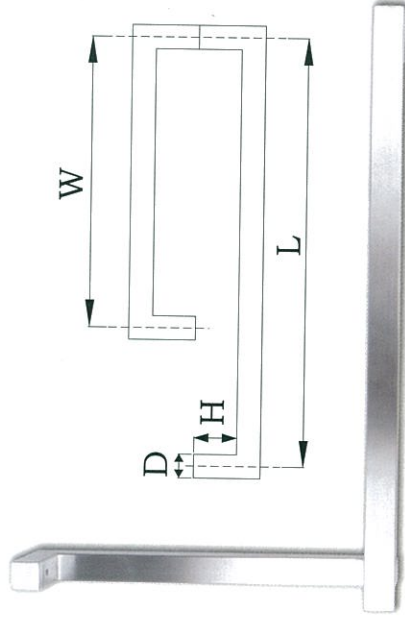

PULL HANDLE

HD 190



Size/mm.

Art No.	L	D1	D2	H
3000	450	25 x 25	50 x 50	45

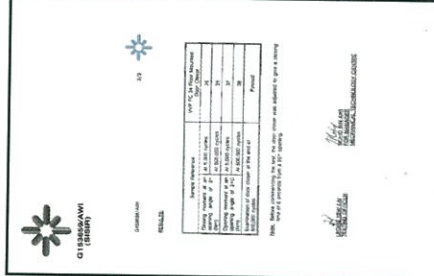
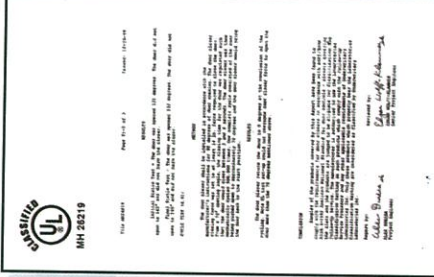
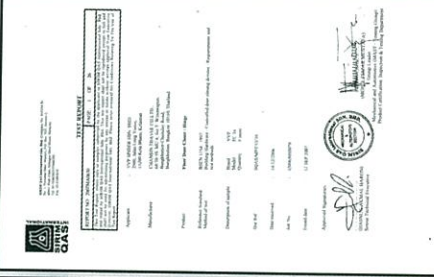
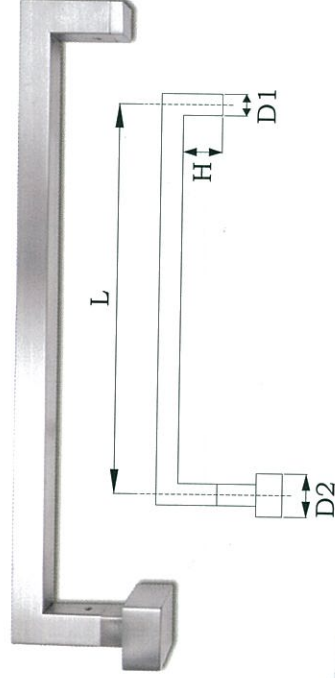

STANDARD FINISH
 PS = POLISHED STAINLESS
 SS = SATIN STAINLESS
 PB = POLISHED BRASS



Tel: 759-2531
 Tel: 1191-2535



MEI 20219



Certification No. A140020457

ล็อคประตูกระจกห้องอาบน้ำ GLASS SHOWER DOOR LOCK

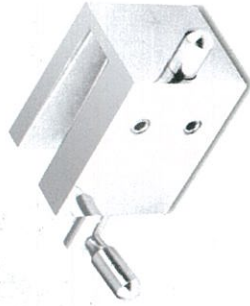

GL 101

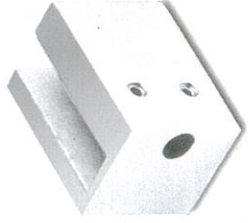
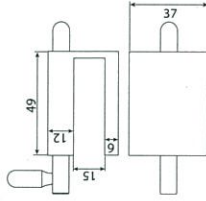

GL 102

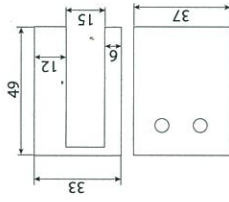

GL 202

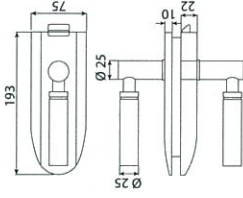

GL 203

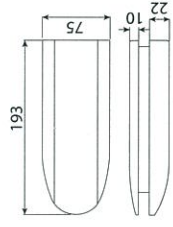

GL 204

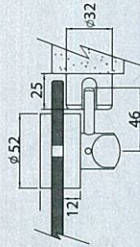
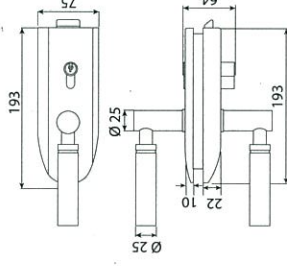

GLW 90 (Fix Wall)

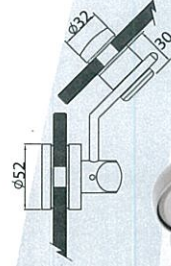

GL 135

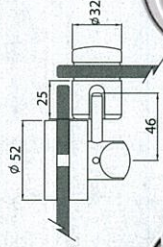

GL 90 (Glass)

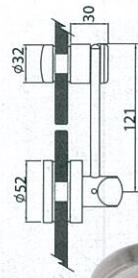
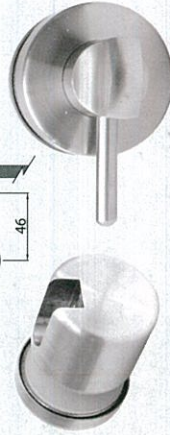

GL 180

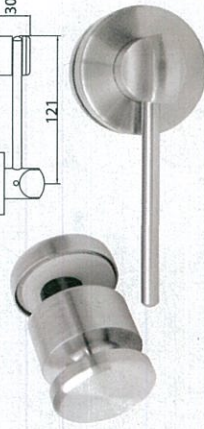

DI III LAMINIC GLASS LOCK AND SHOWER HINGE

ติดต่อ: โทร. 759-2531
 โทร. 1191-2535



STANDARD FINISH
 CP = CHROME PLATED
 PB = POLISHED BRASS
 PS = POLISHED STAINLESS



TIS 754-2551
 TIS 1101-2535



CERTIFIED
 UL
 MH 28219



UL Classified
 Certificate No. AJ4002487

บานพับประตูกระจกห้องน้ำ SHOWER HINGE

บานพับประตูกระจกห้องน้ำ

SHOWER HINGE

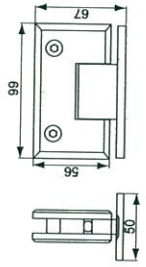
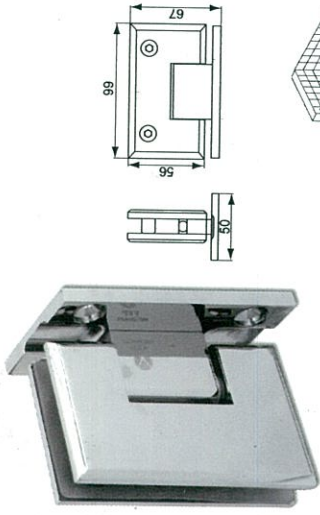

SW 303

Single hinge (Wall/Glass)
 for shower doors or light doors. (8-10 mm. only)

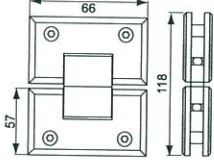
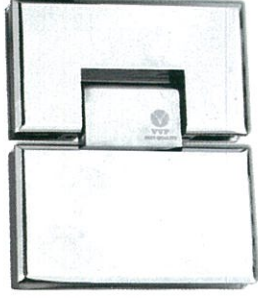
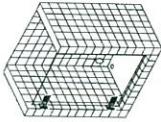

SW 304 (180°)

Double hinges (Glass/Glass)
 for shower doors or light doors. (8-10 mm. only)

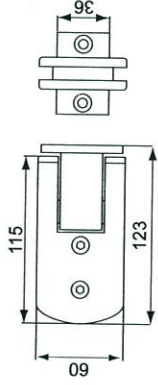
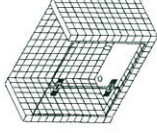

SW 307

Single hinge (Wall/Glass)
 for shower door or light door. (8-10 mm. only)

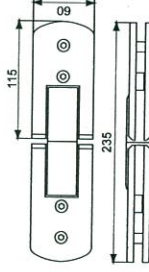
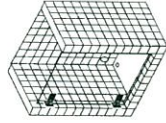

SW 308 (180°)

Double hinges (Glass/Glass)
 for shower door or light door. (8-10 mm. only)

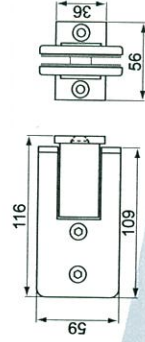
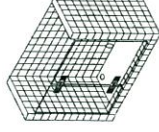

SW 309

Single hinge (Wall/Glass)
 for shower door or light door. (8-10 mm. only)

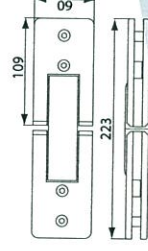
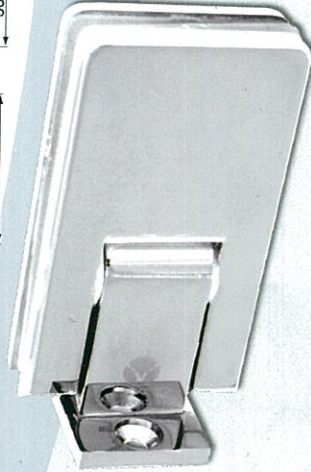

SW 310 (180°)

Double hinges (Glass/Glass)
 for shower door or light door. (8-10 mm. only)

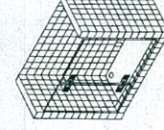

STANDARD FINISH
 CP = CHROME PLATED
 PB = POLISHED BRASS
 PS = POLISHED STAINLESS



UL
 MH 28219



UL
 Certificate No. A14202437

บานพับประตูกระจกอาบน้ำ

บานพับประตูกระจกอาบน้ำ SHOWER HINGE

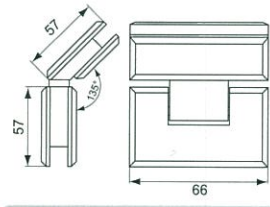

SW 3041 (135°)

Double hinges (Glass/Glass)
 for shower doors or light doors. (8-10 mm. only)

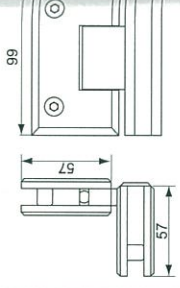
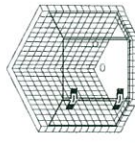

SW 3049 (90°)

Double hinges (Glass/Glass)
 for shower doors or light doors. (8-10 mm. only)

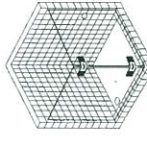

DI III PLANIFIC SHOWER HINGE

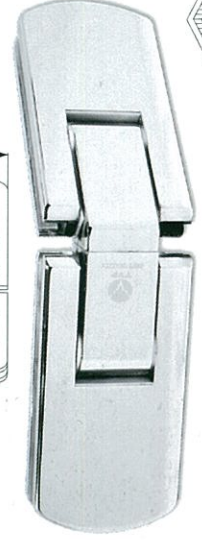
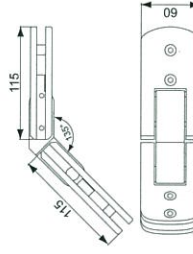

SW 3081 (135°)

Double hinges (Glass/Glass)
 for shower door or light door. (8-10 mm. only)

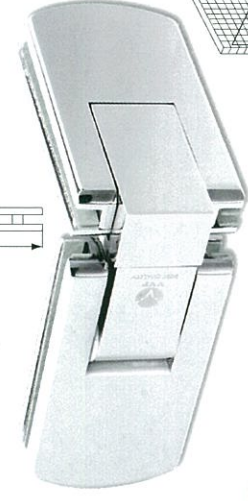
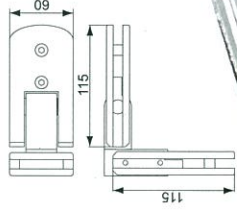
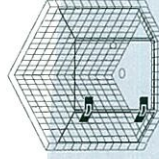

SW 3089 (90°)

Double hinges (Glass/Glass)
 for shower door or light door. (8-10 mm. only)

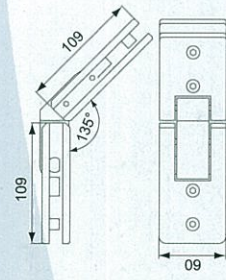
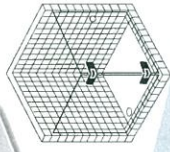

SW 3101 (135°)

Double hinges (Glass/Glass)
 for shower door or light door. (8-10 mm. only)

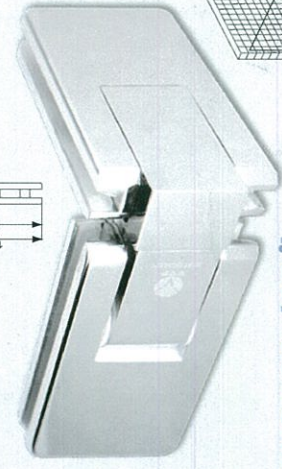
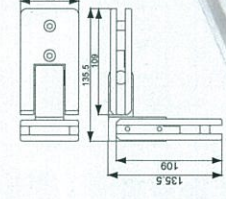
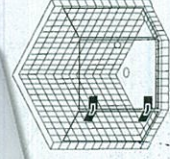

SW 3109 (90°)

Double hinges (Glass/Glass)
 for shower door or light door. (8-10 mm. only)

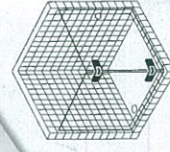

STANDARD FINISH
 CP = CHROME PLATED
 PB = POLISHED BRASS
 PS = POLISHED STAINLESS



มีฉลป้ร:ตุรจกท้อฉลป้ร GLASS DOOR KNOBS

มีฉลป้ร:ตุ

GLASS DOOR KNOBS

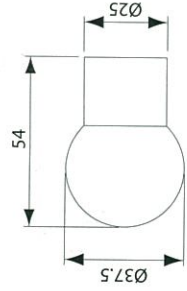

SK-1

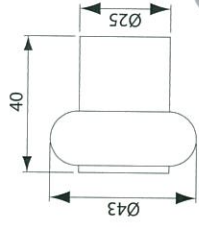

SK-2

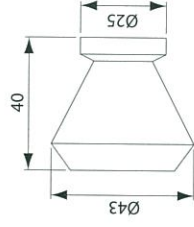

SK-3

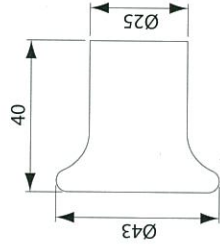

SK-4

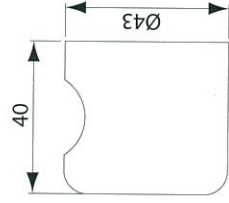

SK-5

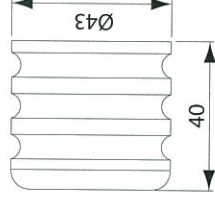

SK-6

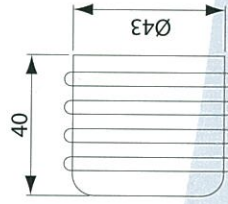

SK-7

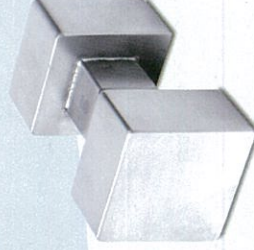
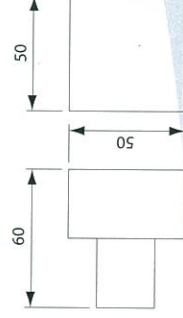

SK-8



STANDARD FINISH
 PS = POLISHED STAINLESS
 SS = SATIN STAINLESS
 PB = POLISHED BRASS



013055/AWT
 (S&B)



UL
 CLASSIFIED
 MH 26219



Certificate No. AJ1002427

ตัวยึดประตู: ท่อน้ำหนักท่อ

ตัวยึดประตู: ท่อน้ำหนักท่อ STRENGTHENING BAR

Tubular Type



SB 900



SB 901

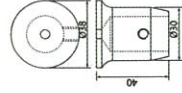

SB 902

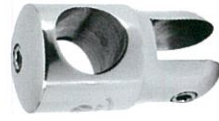

SBR 903

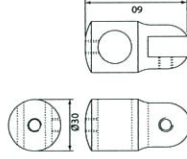

SE 904



SER 905

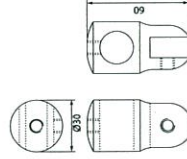

SBF 906



SB 907

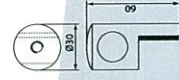

Square Type



SBQ 800

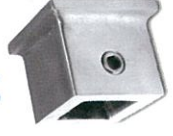

SBQ 801

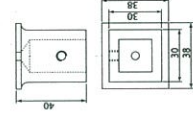

SBQ 802



SBQ 803

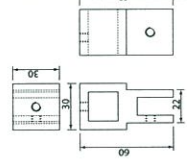

SBQ 804

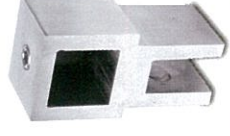

SBQ 805

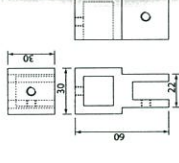

SBQ 806

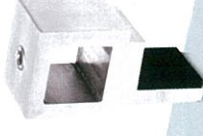

SBQ 807

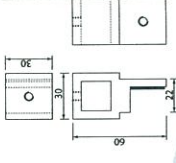

DS

(STAINLESS STEEL DOOR SEAL) LENGTH 810 MM.



STAINLESS STEEL PIPE

(ANY LENGTH MADE TO ORDER)



STAINLESS STEEL PIPE

(ANY LENGTH MADE TO ORDER)

POLYCARBONATE SEAL



PS 10



PS 11



PS 12A



PS 12B



PS 13



PS 14



PS 15



PS 16

PS 17

PS 18

STRENGTHENING BAR

DI III HANDLE



STANDARD FINISH
 PS = POLISHED STAINLESS
 SS = SATIN STAINLESS
 PB = POLISHED BRASS



ตัวหนีบกระจกห้องน้ำใหญ่ SHOWER FITTING

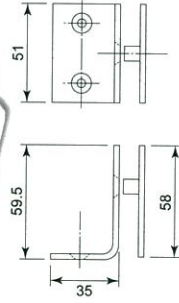
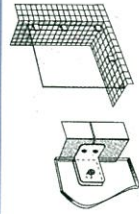

SF 430

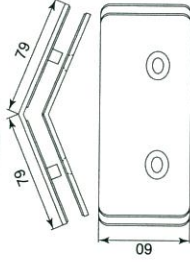
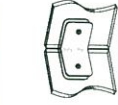

SF 431 (135°)

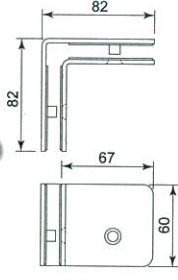

SF 439 (90°)

ตัวหนีบกระจกห้องน้ำเล็ก SMALL SHOWER FITTING

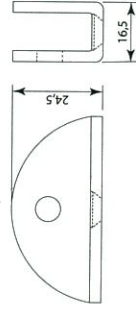

GC-501

To fix glass panel to wall or floor
 For 8 mm. & 10 mm. glass

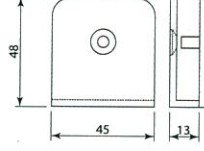

GC-502

To fix glass panel to wall or floor
 For 8 mm. & 10 mm. glass

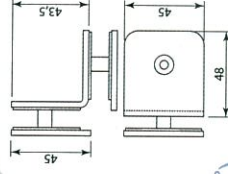
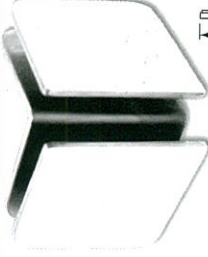

GC-503 (90°)

To fix two glass panels as a
 90° angle For 8 mm. & 10 mm. glass

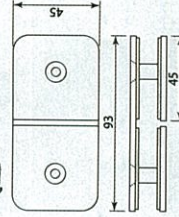

GC-504 (180°)

To hold two glass panels in line
 For 8 mm. & 10 mm. glass

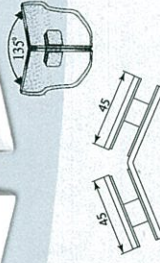

GC-505 (135°)

To fix two glass panels as a
 135° angle For 8 mm. & 10 mm.
 glass

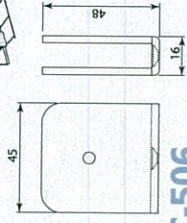

GC-506

To fix glass panel to wall or
 floor For 8 mm. & 10 mm. glass

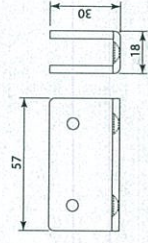

GC-507

To fix glass panel to wall or
 floor For 8 mm. & 10 mm. glass

ตัวหนีบกระจกห้องน้ำ

SHOWER FITTING



STANDARD FINISH
 PS = POLISHED STAINLESS
 SS = SATIN STAINLESS
 PB = POLISHED BRASS



UL Classified
 T18 709-2531
 T18 1101-5253

UL Classified
 M11 26210

UL Classified
 Certificate No. AJA002427

ຕັ້ງສັນຕິພາບກະຕຸ້ນ GLASS CONNECTION

ຕັ້ງສັນຕິພາບກະຕຸ້ນ

ຕັ້ງສັນຕິພາບກະຕຸ້ນ

GLASS CONNECTION

DI III HANDLE

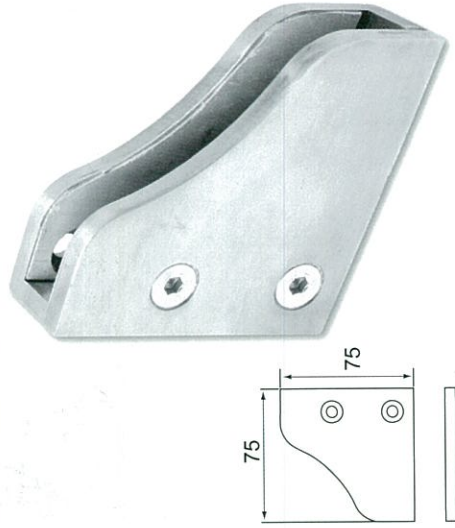

GF 11 L

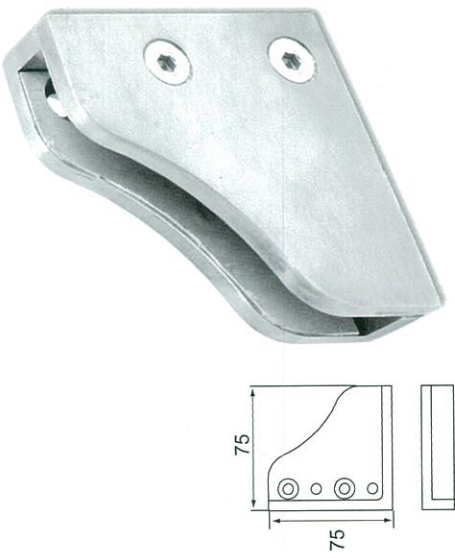

GF 11 R

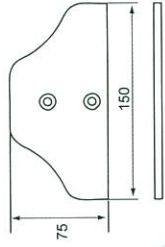

GF 12

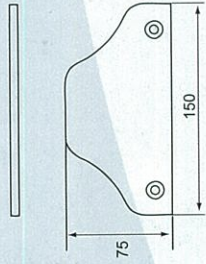
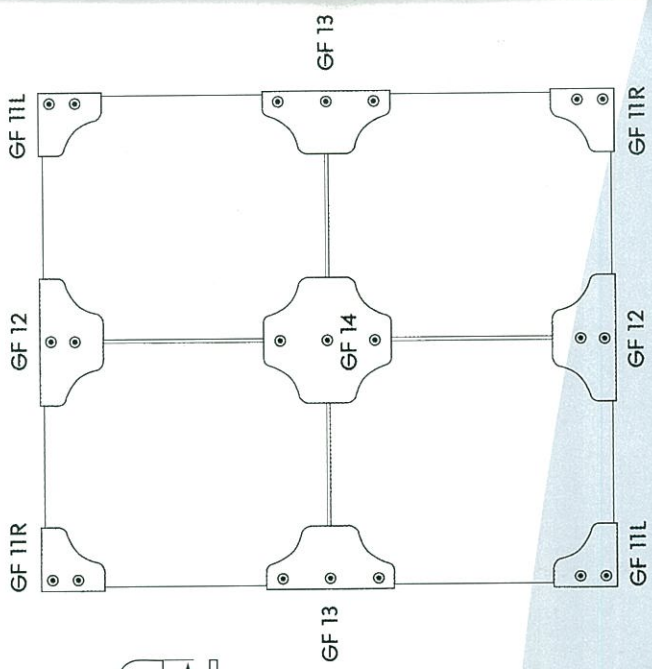

GF 13

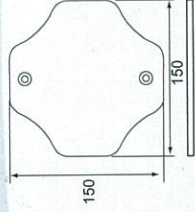

GF 14

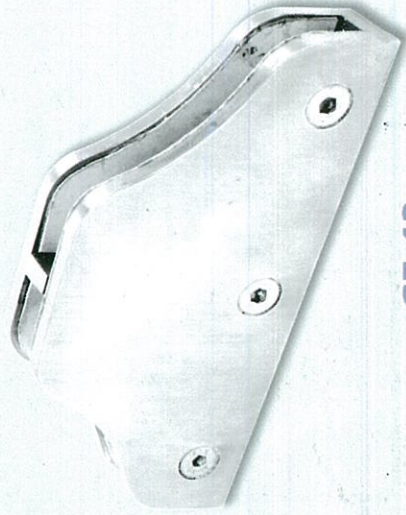

STANDARD FINISH
PS = POLISHED STAINLESS
SS = SATIN STAINLESS
PB = POLISHED BRASS



ตัวเชื่อมต่อกระจก " สปิเดอร์ " SPIDER CONNECTED GLASS

ใบรับรองผล



SIRIM QAS International Sdn. Bhd. (Company No. 410114-X)
No. 1, Persiaran Damansara, P.O. Box 1075, Section 2,
Petaling Jaya, Selangor Darul Ehsan, Malaysia
Tel: 603-55484583
Fax: 603-55484583

REPORT NO : 2007CH1574 PAGE: 1 OF 4

This Test Report refers only to samples submitted by the applicant to SIRIM QAS International Sdn. Bhd. and issued by SIRIM QAS International Sdn. Bhd. It does not cover any other samples or materials. This report should not be used for advertising purposes by any means or forms, without written approval from Executive Director, SIRIM QAS International Sdn. Bhd. (where appropriate) for Certified Reporting to the Use of Test Report.

Applicant : YVP SPIDER SDN. BHD.
2960, Jalan Long Yunas,
15200 Kota Bharu,
Kelantan Darul Naim.

Manufacturer : CHANSIN THAVEE CO.LTD. THAILAND.

Product : Glass Grip (Spider)

Reference Standard/ Method of test : Company's Specification :-
1) Compression Test
2) Chemical Composition Test.

Description of sample : 2 samples of Glass Grip (Spider) were received for testing.
Brand : YVP
Model : SD 444
Grade : SUS 316

Date received : 30 / 10 / 2007

Job No./Ref. No. : J20075941479SQASCBMT77-REC:MSL03

Issued date : 14 NOV 2007

Approved Signatures

(MOHD. AMIR ABDULLAH)
Technical Executive



(SERI HANIN SUWANGI)
Civil & Construction Section
Product Certification, Inspection & Testing Department

CERTIFICATE

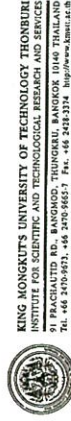

KING MONGKUT'S UNIVERSITY OF TECHNOLOGY THONBURI
INSTITUTE FOR SCIENTIFIC AND TECHNOLOGICAL RESEARCH AND SERVICES
81 PHRACHULIT RD., BANGKOK, THUNGKRU, BANGKOK 10146 THAILAND
Tel. +66 24059671, +66 240746537 Fax. +66 24083334 http://www.kmutt.ac.th

Our ref : STTB-1333

CERTIFICATE OF INSPECTION

CLIENT : CHAN THAVEE CO. LTD.
PLACE OF INSPECTION : WELDING SECTION, KAMUIT
SUBJECT : COMPRESSION TEST
TITLE : SPIDER FITTING
MATERIAL : SUS 316 L
DATE OF INSPECTION : 09E1 2007

WE REPORT AS FOLLOW :
1. COMPRESSION TEST

BY ISSUING THIS CERTIFICATE THE TEST CENTER MAKES NO WARRANTY OF ANY KIND AND NEITHER SHALL THE TEST CENTER BE LIABLE FOR ANY FEDERAL ENERGY OR PROPERTY DAMAGE ARISING FROM OR CONNECTED WITH THIS INSPECTION.

INSPECTED BY
DOLNTHE BURANJANANT (ASSOC.PROF.DR.DR. LIAOWATTANA)
DIRECTOR INSTITUTE FOR SCIENTIFIC AND TECHNOLOGICAL RESEARCH AND SERVICES

Reference to the official website : www.kmutt.ac.th is given the name of the university and the product website : www.yvp.com

V V P SPIDER FITTING CALCULATED MAX. CAPACITY OF SUS 316L SS.

SPIDER FITTING	LATERAL CAPACITY			VERTICAL CAPACITY		
	@ 45°	WHOLE FTG.	ARM'S DEFLECTION	@ 45°	WHOLE FTG.	ARM'S DEFLECTION
(KN)	(KN)	(MM.)	(KN)	(KN)	(KN)	(MM.)
SD 111	3.2975	34.581	3.2975	34.581	3.2975	34.581
SD 222	3.2975	34.581	6.095	68.163	3.2975	34.581
SD 333	3.2975	34.581	10.04	109.49	3.2975	34.581
SD 444	3.2975	34.581	13.39	146.33	3.2975	34.581
SD 555	3.2975	34.581	16.95	183.15	3.2975	34.581
SOC 300	3.2975	34.581	6.095	68.163	3.2975	34.581
SOC 504	3.2975	34.581	13.39	146.33	3.2975	34.581

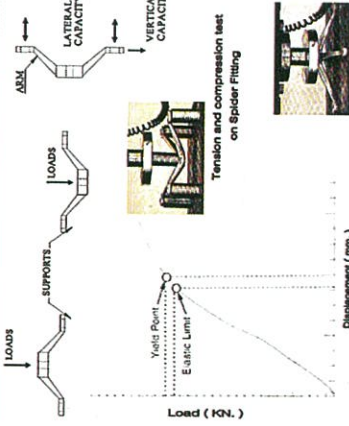

STANDARD FINISH
 PS = POLISHED STAINLESS
 SS = SATIN STAINLESS
 PB = POLISHED BRASS



תצורת חיבור "אטור" (תצורת חיבור)

תצורת חיבור "אטור" (תצורת חיבור) SPIDER CONNECTED GLASS (NON-DRILLED FIXINGS)

SD 011

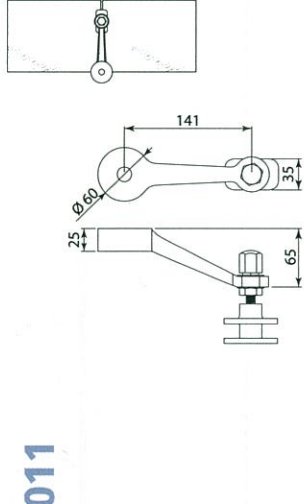

SD 022

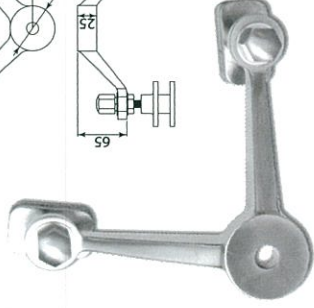
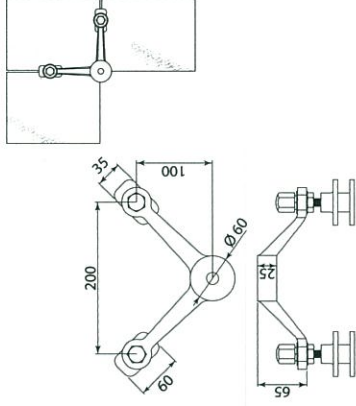

SD 033

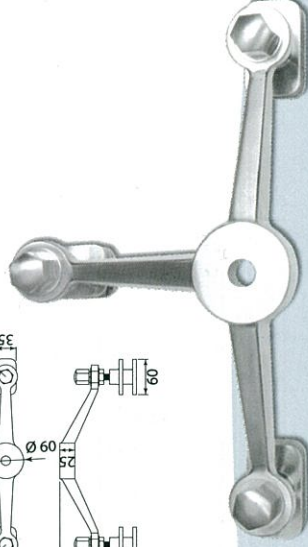
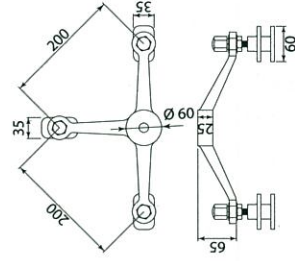

SD 044

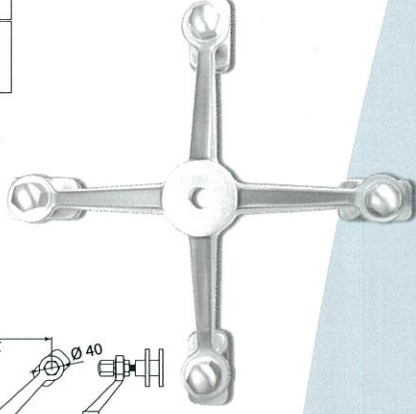
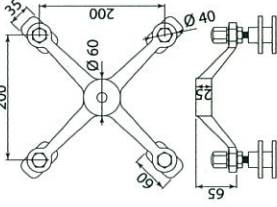

SD 055

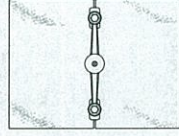

SD 066

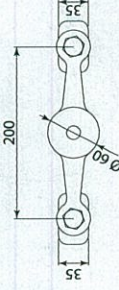
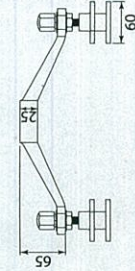
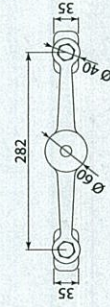
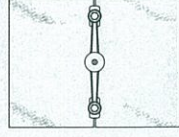

SPIDER CONNECTED GLASS

DI III PLANNING



STANDARD FINISH
 PS = POLISHED STAINLESS
 SS = SATIN STAINLESS
 PB = POLISHED BRASS



ตัวยึดต่อกระจก “ สไปเดอร์ ” SPIDER CONNECTED GLASS

ตัวยึดต่อกระจก “ สไปเดอร์ ”

SD 111

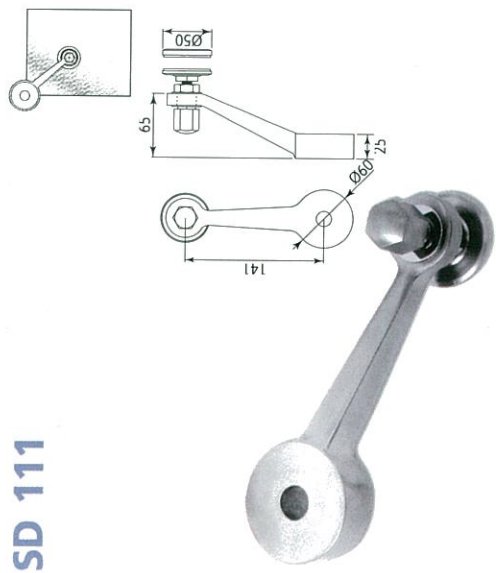

SD 222

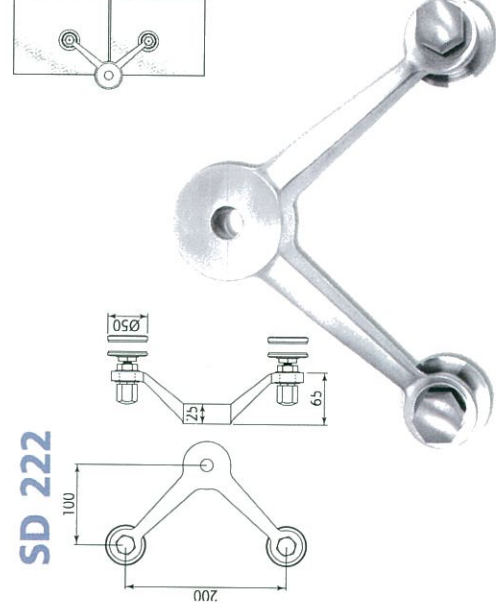

SD 333

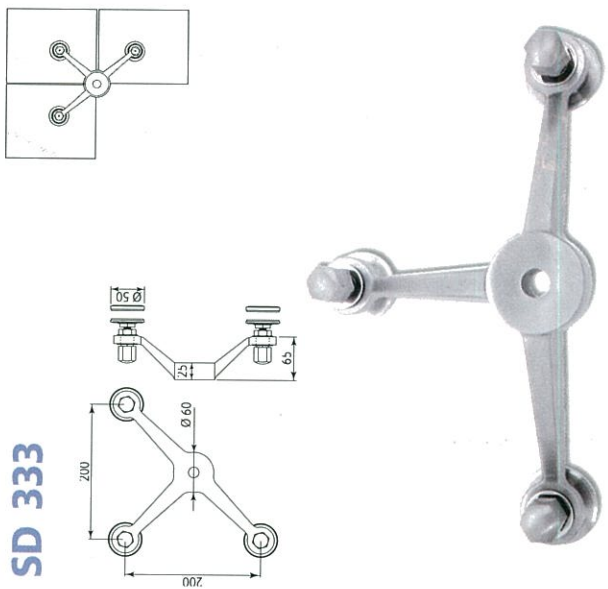

SD 444

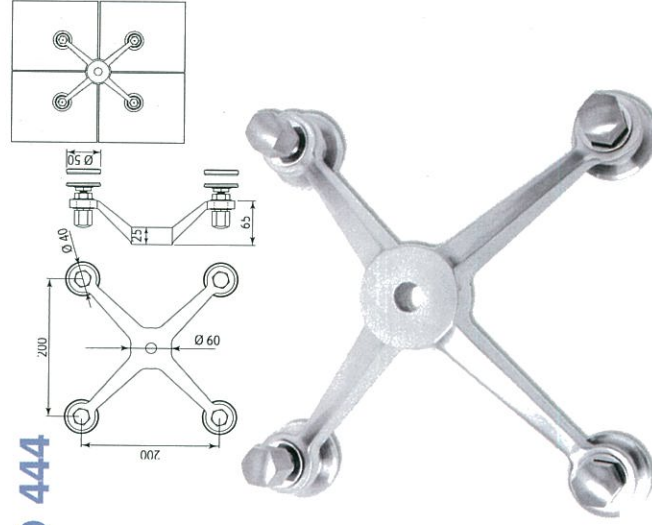

SD 555

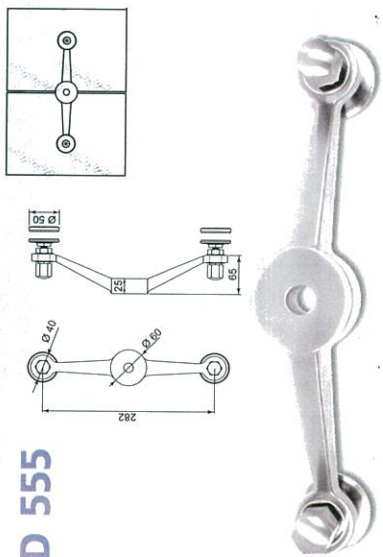

SD 666

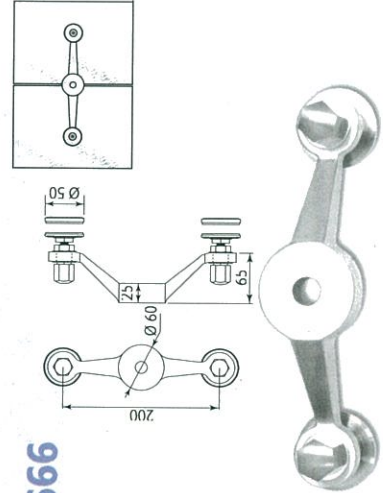

SPIDER CONNECTED GLASS



STANDARD FINISH
 PS = POLISHED STAINLESS
 SS = SATIN STAINLESS
 PB = POLISHED BRASS



ផ្កាត្រីកោណ
 ត្រីកោណ "ស៊ីដាស"

ត្រីកោណ "ស៊ីដាស" SPIDER CONNECTED GLASS

SDC 202

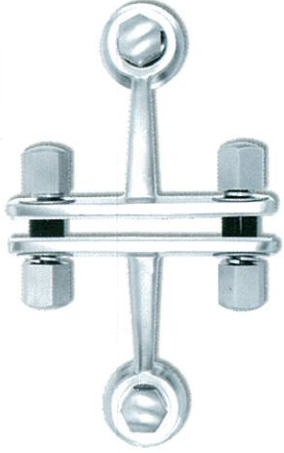
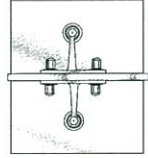

SDC 404

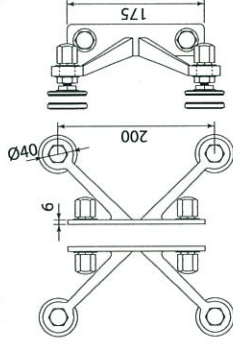
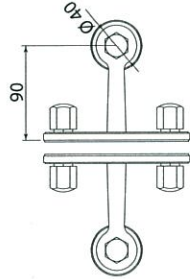
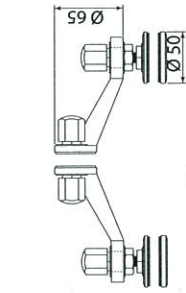
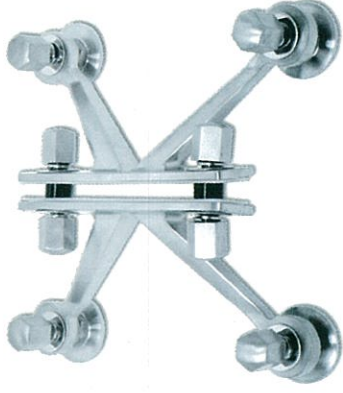
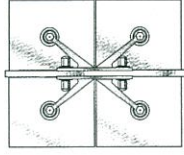

SC 666

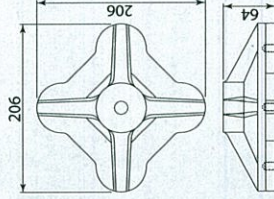
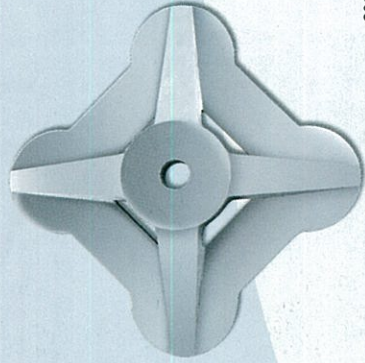
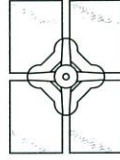

SDB 77

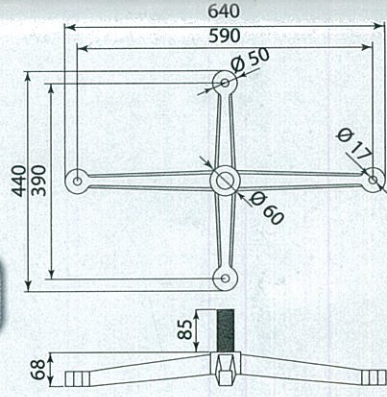
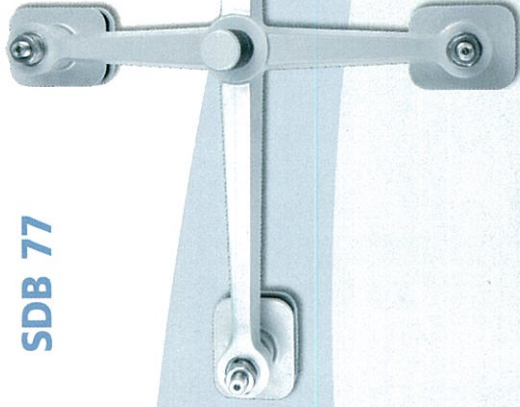
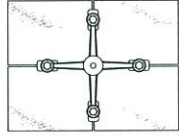

DI III L V A N D I E
 SPIDER CONNECTED GLASS



STANDARD FINISH
 PS = POLISHED STAINLESS
 SS = SATIN STAINLESS
 PB = POLISHED BRASS



ตัวยึดต่อกระจก “ สไปเดอร์ ”

SPIDER CONNECTED GLASS



SWIVEL BOLT JOINT



SFH 01



SRH 02

FIX POINT

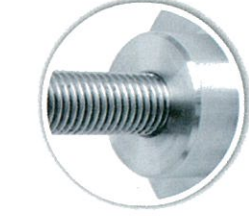

FH 03



RH 04

SWIVEL BOLT JOINT

(NON-DRILLED FIXINGS)

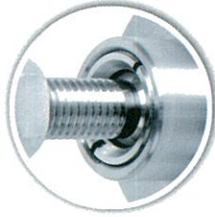
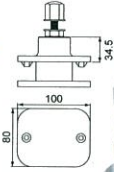

SQH 07

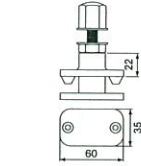

SQH 05

FIX POINT

(NON-DRILLED FIXINGS)

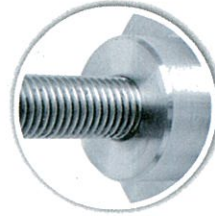
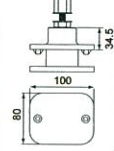

QH 08

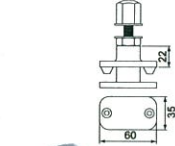

QH 06

SWIVEL BOLT JOINT

(NON-DRILLED FIXINGS)

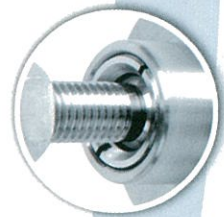
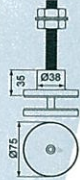

SQH 10



SQH 09

FIX POINT

(NON-DRILLED FIXINGS)

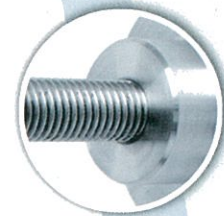
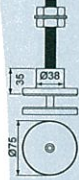

QH 12

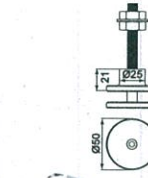

QH 11

STANDARD FINISH

PS = POLISHED STAINLESS

SS = SATIN STAINLESS

PB = POLISHED BRASS



G13K566/AW1
(SGSR)



TIS 759-2531
TIS 1101-2335



MH 20219



Certificate No. AJA0072487

ACCESSORIES FOR TENSION ROD

SWIVEL JOINT

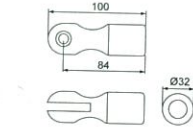

TS 11

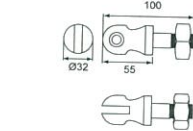

TS 22

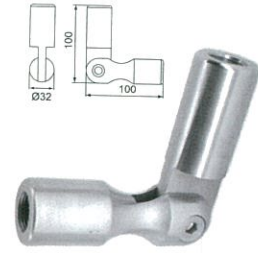

TS 33

PLATE CONNECTION

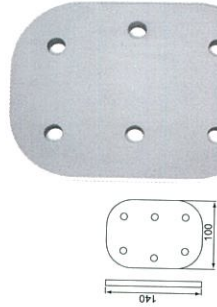

TS 44

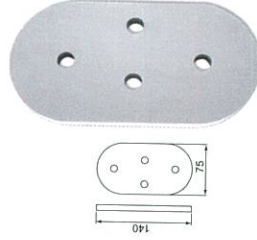

TS 55

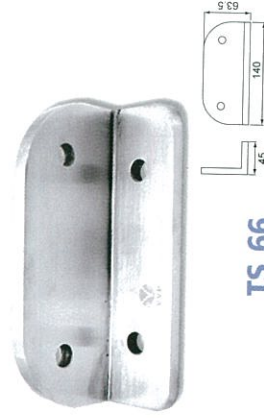

TS 66

PLATE BASE

ACCESSORIES FOR GLASS CONNECTION

WALL CONNECTION



CW 60

PLATE CONNECTION 180°

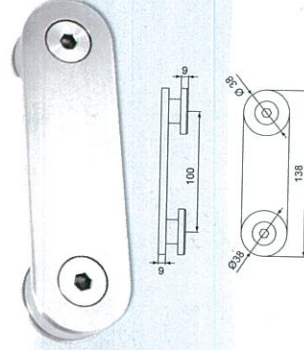

CP 180

FIN CONNECTION

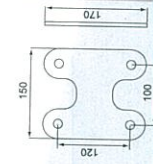

CF 20



CF 30

CORNER CONNECTION 90°

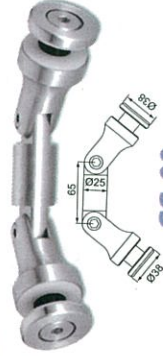

CC 90

CORNER CONNECTION 135°

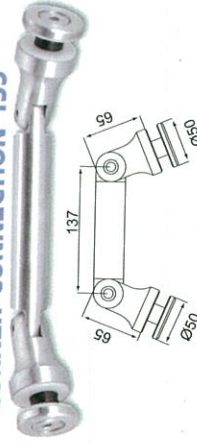

CC 135

Stainless steel Tension Rod Truss stand & Linkages Dia. 19 mm. (3/4")



Any length are available by order TS 77





BS 10

กลองประตูบานลัดจ์ หัว
VVP FLUSH BOLTS

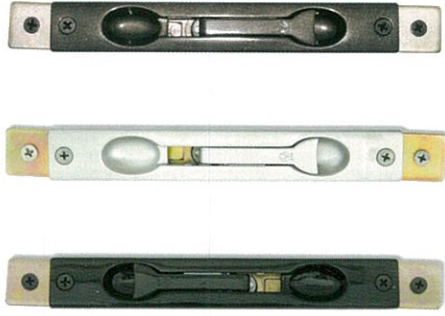

Finish : Chrome, Brown, Black, Silver

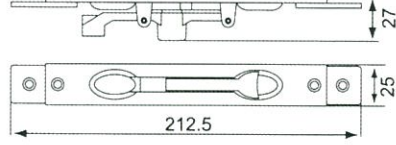

US 20

กลองประตูบานลัดจ์ หัว
VVP FLUSH BOLTS

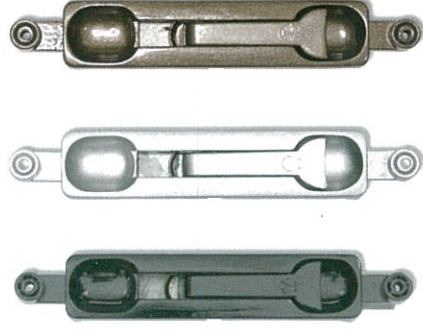

Finish : Brown, Black, Silver

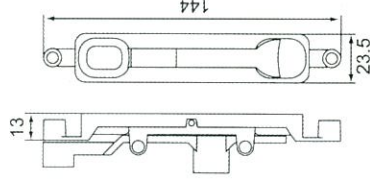

FH

บานพับยึดคานา ฟรอกัน หัว
VVP FRICTION STAY HINGE

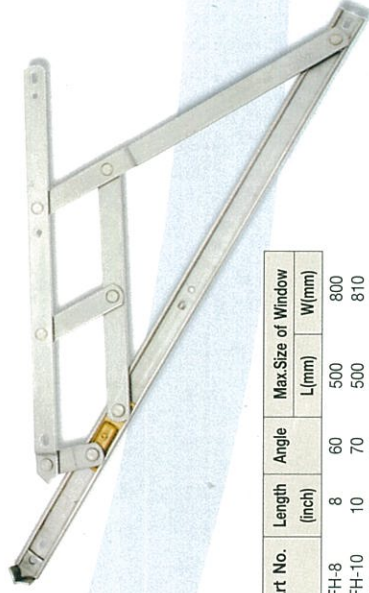

Art No.	Length (inch)	Angle	Max.Size of Window	
			L(mm)	W(mm)
FH-8	8	60	500	800
FH-10	10	70	500	810
FH-12	12	50	580	850
FH-14	14	60	700	1150
FH-16	16	25	800	1200
FH-18	18	20	850	1300
FH-20	20	45	950	1300
FH-24	24	45	980	1350

SA

แขนค้ำบานประตู หัว
VVP SUPPORT ARM

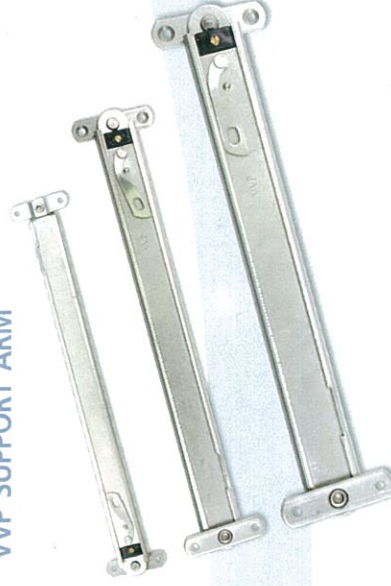

Art No.	Length (inch)
SA 10	10
SA 12	12
SA 14	14



V 39 ฤๅจๅนเลๅน ฤๅ: ฤๅจๅนสวๅง วๅวๅ VVP HOOK LOCK AND DEAD LOCK

Art No.	Position
SL-1	SLIDE DOOR, ONE WAY LOCK
SL-2	SLIDE DOOR, TWO WAY LOCK
SW-1	SWING DOOR, ONE WAY LOCK
SW-2	SWING DOOR, TWO WAY LOCK

FINISH :
 AL = ALUMINIUM
 BW = BROWN
 SS = STAINLESS STEEL

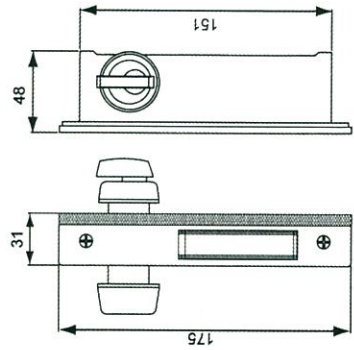

DOOR ACCESSORIES

VL 43 ฤๅจๅนเลๅน ฤๅ: ฤๅจๅนสวๅง วๅวๅ VVP HOOK LOCK AND DEAD LOCK

Art No.	Position
HL-1	SLIDE DOOR, ONE WAY LOCK
HL-2	SLIDE DOOR, TWO WAY LOCK
DL-1	SWING DOOR, ONE WAY LOCK
DL-2	SWING DOOR, TWO WAY LOCK

FINISH :
 AL = ALUMINIUM
 BW = BROWN

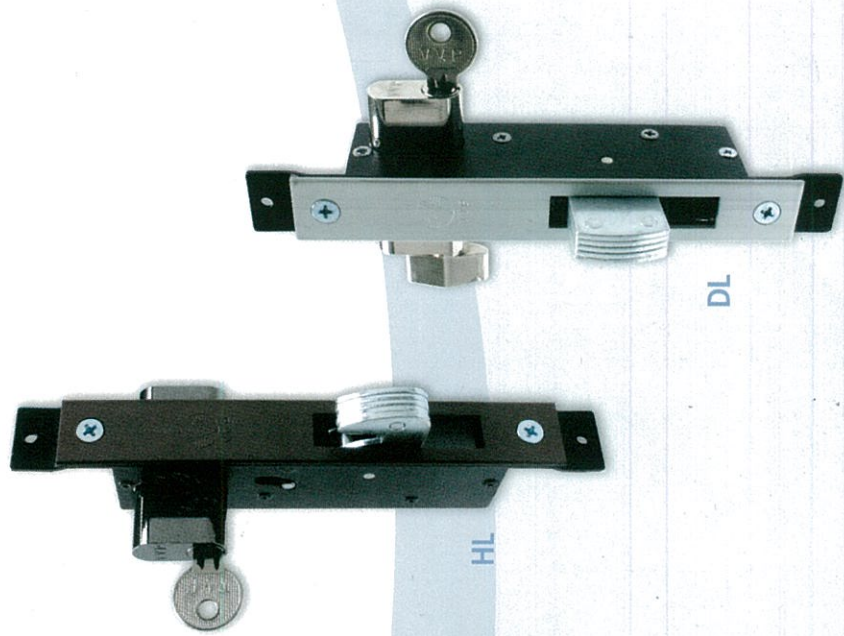
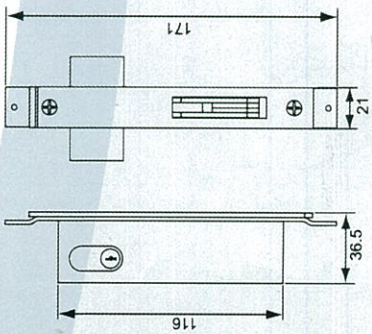



VVP FACTORY



บริษัท วีพี มาร์เก็ตติ้ง จำกัด
VVP MARKETING CO., LTD.

283 ถนนพระราม 2 ตำบลสามด้า เขตบางขุนเทียน กรุงเทพฯ 10150

Tel. (66-2) 416 8963-4, 416 2708, 894 0020-6, 894 1001-6 Fax: (66-2) 415 4743, 894 1008, 840 1474

e-mail : vpcsv@ksc.th.com, sales@vvpmarketing.com website : www.vvpmarketing.com